



Operating & Installation Manual

The Becton MK 3 Range of Gas Stoves



(Becton 7 MK 3 Gas Stove)

PLEASE RETAIN THESE INSTRUCTIONS FOR FUTURE REFERENCE

Aarrow Fires Ltd
The Fireworks
Bridport
Dorset, DT6 3BE
Great Britain

Tel. (44) 01308 427234
Fax. (44) 01308 427441
www.aarrowfires.com



FOR USE IN COUNTRIES
GB & IE

Rev 11
Part No. AFS1125

Congratulations on your choice of an Aarrow Stove.

More than 20 years experience has been put into the development of our Becton Family to ensure ultimate performance and years of trouble free enjoyment.

Every detail on the fire has been carefully engineered and designed which is why we are so confident in the reliability of our product that we offer a Lifetime Guarantee.

Should you have any questions about our Becton Stoves that are not covered in this manual, please contact the Aarrow dealer in your area, or call our Technical support department on
01308 427234

Flaming Good Fires!

© COPYRIGHT March 2004

Aarrow Fires Ltd

This booklet has copyright & may not be copied in whole or part or used for any purpose other than that for which it is supplied without express written consent from Aarrow Fires Ltd.

	Page		Page
INTRODUCTION		SERVICING	
Safety Notices	4	Details of Pilot Assembly	18
General Information	4	Door Trim	19
Statutory Requirements	5	Fire Door Glass & Seal	19
OPERATING INSTRUCTIONS		Burner Assembly	20
Technical Data	6	Regular Service	20
Fire Dimensions	6	Annual Service	21
Fitting the Lining Panels	7	Cleaning Outer Services	21
Arranging the Coals	8	Cleaning Door Glass	21
Lighting & Controlling The Fire	9-10	Fault Diagnosis	22
INSTALLATION		SPARE PARTS	
Installing The Fire	11	General Components	23
Fitting The Feet	11	Accessories and Options	23
Flue System	11-13	Notes	24-25
Fire Location	13	Spare Parts List	26-28
Combustible Shelf Clearances	14	GUARANTEE	
Hearth Requirements	15	Lifetime Guarantee	29 & 31
Connecting The Gas Supply	15	Customer Registration	29
Pressure Test Sequence	15	SERVICE RECORD	
Fire Testing	16	Service Record	30
Installation Check List	17	Lifetime Guarantee	31
		Final Factory Checklist	32

INTRODUCTION

References in this manual to British Standards and Statutory Regulations and Requirements apply only to the United Kingdom. For Ireland the rules in force must be used.

Before installation, check that the local distribution conditions, nature of the gas, pressure and the adjustment of the appliance are compatible.

The manual is an important part of the appliance and must by law be handed to the end user on completion of the installation.

SAFETY NOTICES

- Do not attempt to burn rubbish or any other material in this appliance.
- This fire must only be operated with the fire door shut and secured.
- Do not use the appliance if the glass is cracked or broken.
- Do not make any unauthorised modifications to the appliance.
- It is recommended that the fire be guarded to protect the young and infirm using a fireguard complying with BS8423:2002.
- **Coal set** -The coal set contains Refractory Ceramic Fibres (R.C.F), which are man made vitreous silicate fibres. Excessive exposure to these materials may cause temporary irritation to the eyes, skin and respiratory tract. Care must be taken when handling these items to ensure the release of dust particles is kept to a minimum. To ensure that the release of fibre from these items is kept to a minimum, during installation and servicing it is recommended that a vacuum cleaner fitted with H.E.P.A. filters is used to remove any dust, soot or any other debris accumulated in and around the appliance. This should be performed before and after the installation. It is recommended that any replacement item(s) are not broken up but sealed within a heavy duty polythene bag and clearly labelled "R.C.F. waste". This is not classified as "hazardous waste" and may be disposed of at a tipping site licensed for the disposal of industrial waste. Protective clothing is not required when handling these items but it is recommended that gloves are worn and

normal hygiene rules are followed.

Always wash your hands before eating or drinking.

- In the event of a gas emergency, consult the telephone directory and ask for your local gas supplier.

GENERAL INFORMATION

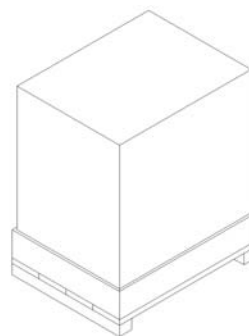

Fig 1

Palletted cardboard carton.
440mm x 560mm x 550mm high

Becton Bunny Packed wt. 45Kg
Becton 7 Packed wt. 56Kg

All materials, appliances and equipment used should be fit for their purpose, be of suitable quality and workmanship and should comply with the applicable British Standards.

Before continuing any further with the installation of this appliance please read the following guide to manual handling.

- Always obtain assistance when lifting the appliance.
- When lifting always keep your back straight. Bend your legs not your back.
- Avoid twisting at the waist. It is better to reposition your feet.
- Avoid upper body/top heavy bending. Do not lean forwards or sideways when handling the fire.
- Always grip with the palms of your hands. Do not use fingertips for support.
- Always keep the stove as close to the body as possible. This will minimise the cantilever action.
- Use gloves to provide additional grip.

IMPORTANT NOTICES

A qualified gas engineer must carry out the installation and servicing of this appliance in accordance with these instructions and in compliance with current Building Regulations. ***Such person must be a registered CORGI engineer.***

This appliance is designed to run on natural gas only. **Warning - Only use the appliance with the specified gas.**

The fire is fitted with a safety device to shut down the appliance if there is inadequate flue draw. If the fire shuts down for no apparent reason check chimney and air inlets to the room. In all cases the fire must not be re-lit until the safety aspects have been checked by a qualified gas engineer.

Please note the following;

- The safety device must **never** be put out of action.
- Sealed components must not be interfered with.
- Servicing instructions and part identification numbers are given towards the back of the manual.
- Only use genuine **Aarrow** parts for replacements.
- Ventilation, purpose built ventilation is not normally required for either appliance, normal adventitious room ventilation being sufficient.
- Coal Set, see safety notice on page 4.

All surfaces except the control knob, the control door handle and control door are considered to be working surfaces.

Warning: Under no circumstances must the fire be operated if the glass is cracked or broken.

Warning: If it is known or suspected that an operational or ignition fault exists on the appliance, it must not be used until it has been investigated and corrected by a qualified gas engineer.

Warning: THIS GAS APPLIANCE MUST BE SERVICED EVERY TWELVE MONTHS BY A QUALIFIED GAS ENGINEER.

STATUTORY REQUIREMENTS

The current Gas Safety (Installation and Use) Regulations (as amended).

The Building Regulations for England and Wales 2000 ref Approved Document J 2002 edition (issued by the DTLR).

The Building Standards (Scotland) (Consolidation) Regulations.

Detailed recommendations are outlined in the current issue of the following British Standards:- BS5440 parts 1 and 2, BS5871 part 1 and BS6891.

Any Manufacturer's Instructions must not be taken as overriding statutory requirements.

CERTIFICATION

This appliance is CE certificated for performance and safety. Therefore, it is important that no alteration is made to the appliance.

Any alteration not approved by **Aarrow Fires Ltd.** will invalidate the guarantee.

OPERATING INSTRUCTIONS

TECHNICAL DATA Category I _{2H} For use in GB and IE at a supply pressure of 20mbar		
	Becton Bunny Natural Gas	Becton 7 Natural Gas
Main Burner	Aeromatic AC13/112511 (mod 334)	Aeromatic AC13/112511 (mod 334)
Injector	Bray 82-700	Bray 82-700
Max. Heat Setting		
Heat Input (net)	3.7 kW	5.0 kW
Gas Rate	0.391m ³ /hour	0.529m ³ /hour
Cold Setting Pressure	1.5mb	3.5mb
Min. Heat Setting		
Heat Input (net)	2.4 kW	3.3 kW
Gas Rate	0.254 m ³ /hour	0.349 m ³ /hour
NO _x CLASS	CLASS 4	CLASS 4

FIRE DIMENSIONS

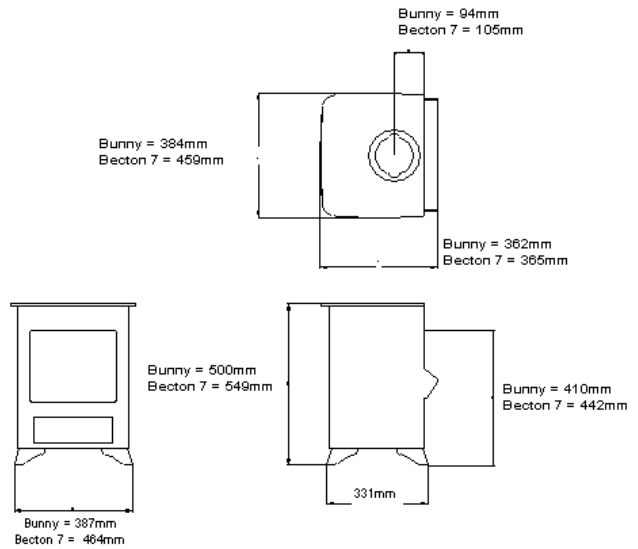

Fig. 2

FITTING THE LINING PANELS

Becton 7 only. The lining panels supplied are to be installed into the fire before the coal matrix is fitted. Note: The lining panels are reversible (brick or plain pattern)

Ensure the appliance is cold.

With the fire door open, the glass retaining frame and the coal set removed, proceed as follows:

Do not force the linings into position.

1. Position the rear lining face down at the rear of the fire. Ensure the cutout faces the rear of the fire.

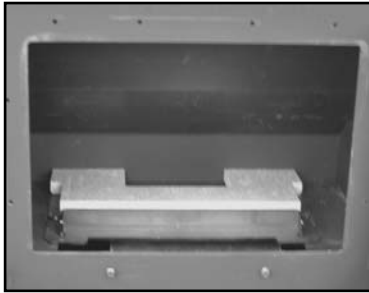

Fig. 3a Positioning the rear lining

2. Locate side lining in the right hand side of the fire. First position the tall edge into the radius at the front of the fire.(See Fig.3b below)



Fig. 3b Fitting the R/H side lining

3. Then rotate the rear edge until the top faces match up the angle faces at the rear of the fire. (See Fig. 3c) Repeat exercise for the left hand side.



Fig. 3c Fitting the side linings

4. Rotate the rear lining to bring it vertical (Fig. 3d)

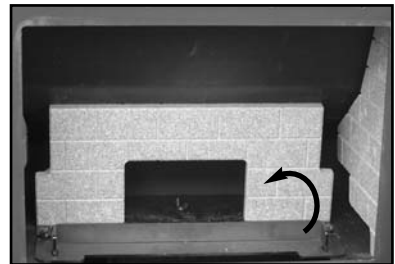

Fig. 3d Rotating the rear lining

5. Centre the assembly. Line up each end of the rear lining with the edges of the fixed matrix plate. (See Fig. 3e)



Fig. 3e Liner panels assembled in the fire.

Once the lining panels are fitted, arrange the coals. See “Arranging the coals” on page 8.

OPERATING INSTRUCTIONS

ARRANGING THE COALS

Safety Notice - Please see SAFETY NOTICES ref. Coal set page 4.

Warning: The coals and the coal matrices are fragile ensure they are handled carefully.

Ensure location is correct. Do not force the matrix into position. If the coals and/or the coal matrices are damaged they must be replaced with genuine Aarrow replacement sets.

Warning: An incorrect coal layout may cause soot to build up inside the fire and therefore invalidate the guarantee.

Ensure the appliance is cold.

Step 1 Place the base matrix on the matrix plate centrally between the end tabs of the location bar. (Fig 4a)

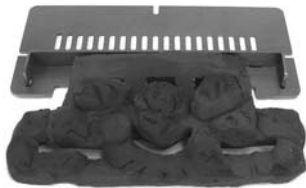

Fig 4a

Step 2 Place the rear matrix cut out section over the base matrix and centralise the assembly between the end tabs of the location bar. Ensure the rear matrix is pushed back against the location bar. (Fig 4b)

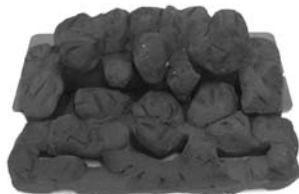

Fig 4b

Step 3 Becton 7 only. Locate 2 off end coals each side of the base matrix. (See underside of coals for hand identification) (Fig 4c).

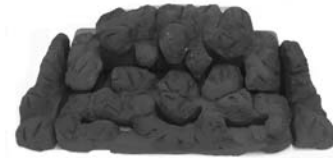

Fig 4c

LIGHTING & CONTROLLING THE FIRE

Under no circumstance must the fire be operated if the glass is cracked or broken.

Open the gas control access door situated at the bottom of the appliance. **Always use the control door HANDLE.**

Step 1a. To ignite the pilot push the control knob in, turn anti-clockwise towards the spark position and hold in for 15 seconds. (Fig 5a)

The pilot can be viewed through the L/H & centre front slots in the base matrix.

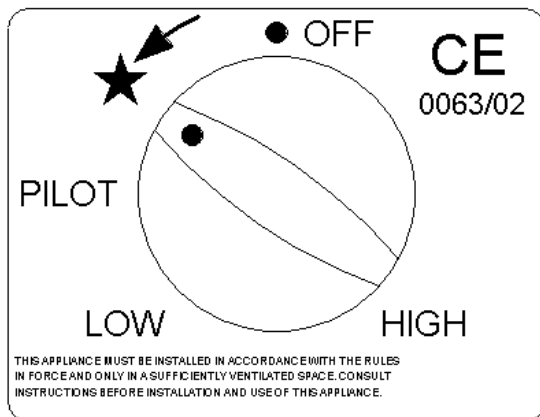
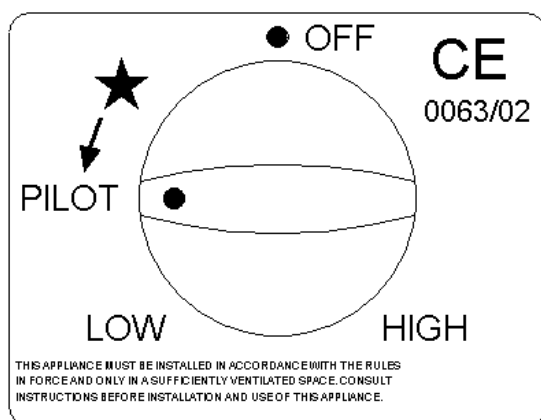

Fig 5a

Step 1b. Keep the control knob pressed in and turn



anti-clockwise to the pilot position. (Fig 5b)

Fig 5b

Step 1c. Keep the control knob pressed in for a further 15 seconds and then release. The pilot will remain alight.

If pilot does not remain alight repeat this procedure.

Please note that when purging the gas supply it is usual to have to keep the control knob depressed in the spark position for longer periods of time.

Step 2. To ignite the main burner, rotate the control knob anti-clockwise to the **HIGH** position (fig 5c)

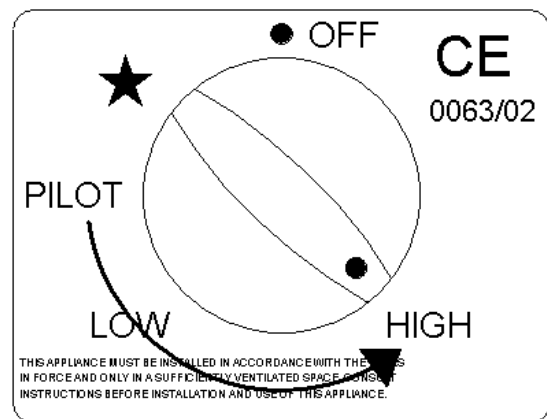

Fig 5c

For maximum heat output leave the control knob at the high position

For minimum heat output, rotate the control knob clockwise to the **LOW** position. (Fig 5d)

OPERATING INSTRUCTIONS

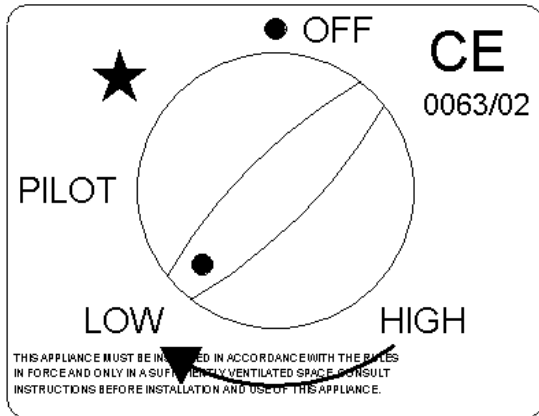

Fig 5d

Step 4. To extinguish the pilot, turn the control knob to the **OFF** position. (Fig 5f)

Incorporated into the pilot assembly is a flame failure device designed to shut off the gas supply in the event of the pilot flame being extinguished while the fire is unattended.

Should the pilot flame blow out accidentally or intentionally whilst the fire is running, **no attempt should be made to re-light the gas for at least three minutes.**

To restart the fire turn the control knob to the off position and repeat the lighting & controlling the fire instructions.

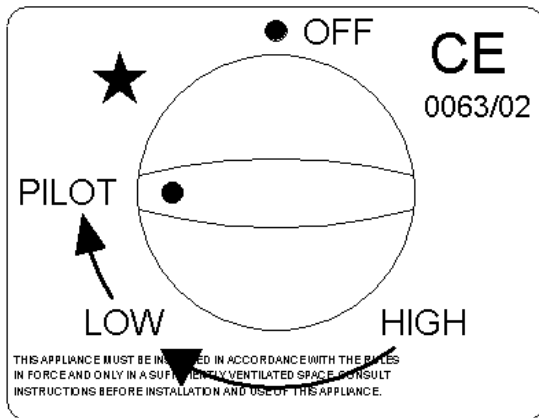

Fig 5e

Step 3. To turn the main burner off while keeping the pilot alight, rotate the operating knob back to the **PILOT** position. (Fig 5e)

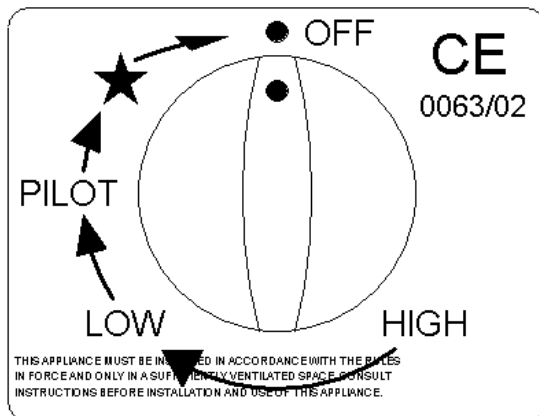

Fig 5f

The flame failure device is a safety feature required by law and must not be put out of action by the installer. If this device or any of its parts are to be replaced, only original manufacturer's parts are to be used.

Repeated operation of the flame failure device indicates that there maybe a problem with the flue draw. In this situation no more attempts at operating the appliance should take place and your qualified gas engineer should be contacted to investigate and rectify the problem.

INSTALLATION

INSTALLING THE FIRE

Your **CORGI** qualified gas engineer should install the fire in accordance with the following regulations and standards:-

The Gas Safety (Installation and Use) Regulations 1998 (as amended).

The Building Regulations for England and Wales 2000 ref; Approved Document J 2002 edition (issued by the DTLR).

The Building Standards (Scotland) (Consolidation) Regulations.

BS5440 parts 1 and 2 1990, BS5871 And these Installation Instructions.

Warning: Failure to comply with the regulations, requirements, or these instructions will invalidate the guarantee and could have hazardous consequences.

Please note that in tight recesses the gas supply point may be inaccessible. Therefore it may be necessary to connect the pipe for the gas supply to the fire before installing the fire into its recess.

FITTING THE FEET

Care should be taken when fitting the feet not to damage the painted surfaces of the fire.

- The feet (4 off) are positioned in each corner of the fire base using the washers and screws provided.

- **Tools required:** A no. 2 pozidrive screwdriver.

FLUE SYSTEM

The stove must be connected to a suitable and efficient flue that provides a good updraught to safely take the products of combustion (fumes) from the stove outlet to the outside air. To ensure a good updraught it is important that the flue gases are kept warm and that the flue size suits the stove.

The termination of the outlet at the top of the flue also needs to comply with the Building Regulations. The minimum effective height of the

chimney must be at least 3 metres and when warm the flue draught should be between 0.05 and 6mb (0.5mm to 6mm water gauge).

The Bunny requires a minimum flue size of 100mm (4 inches) and the Becton 7 requires a minimum flue size of 125mm (5 inches). If the stove is being connected to a chimney with an internal flue size greater than 225mm (9 inches) diameter or 200 x 200mm square, a 125mm (5 inches) diameter stainless steel flexible flue liner complying with BS 715 should be installed in the flue.

If a new chimney is being provided it should fully comply with the relevant Building Regulation Requirements and BS 5440: Part 1. Suitable types of chimney include the following.

- Masonry chimney built with clay or concrete liners, or a chimney block system meeting Building Regulations.

- Precast concrete gas flue block complying with BS 1289: Part 1

Factory made metal chimney complying with BS 715 (often called "Twin wall Class 2 chimney") or Factory made metal insulated chimney complying with BS 4543: Part 2 (often called "Class 1 pre-fabricated metal chimney"). To ensure the flue gases are kept warm an insulated chimney system should be used if the chimney is positioned outside the building.

The flue must be terminated with a suitable chimney pot or cowl and the chimney or flue shall be swept prior to installation unless the chimney is clean and unobstructed.

The flue and chimney installation must be carefully checked by a competent person before fitting the stove to ensure it is suitable and will work safely. The flue must also pass a Flue flow test (smoke test) to BS 5440: Part 1.

**For advice on flues and chimneys contact;
NACE (National Association of Chimney Engineer): telephone 0800 0924019
www.nace.org.uk**

**or
NACS (National Association of Chimney Sweeps): telephone 01785 811732**

The Becton gas stove is designed so that the flue can be fitted to either the top or the rear of the appliance.

Fit the flue spigot and blanking plate for either top or rear flue outlet in accordance with **figure 6a or 6b (below)**.

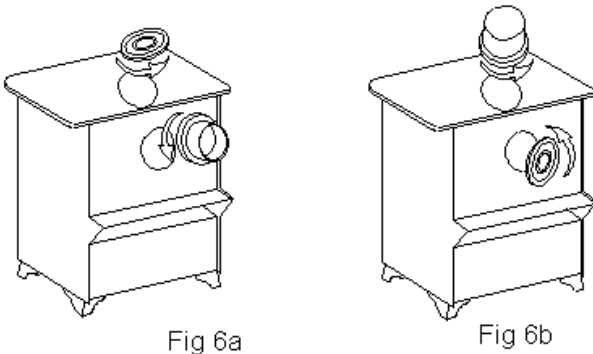

Fig 6a

Fig 6b

Lock the blanking plate in place by rotating anti-clockwise and tighten by tapping gently with a block of wood and mallet. Fit the spigot to the unused opening in the same way. The units are sealed by the attached gaskets.

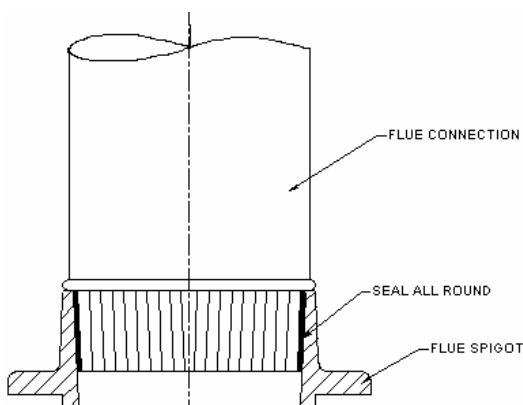

Fig 6c

REAR FLUE

Open Hearth

Fit and seal a 'T' section (with soot box) directly into the flue spigot. The maximum horizontal section allowed is 150mm.

Provide a minimum vertical height of 600mm of flue from the height of the rear flue outlet. See **figure 7b**.

Closure Plate

#Connect the flue spigot to the rear outlet.

#Connect a flue extension to the spigot.

#Fit the closure plate in fireplace.

#Position the fire so the flue extension passes through the hole in the closure plate.

#Ensure all joints are suitably sealed.

See **Figure 7c**.

TOP FLUE

Provide a minimum vertical height of 600mm of flue measured from the top of the appliance. See **Figure 7d**.

Move the fire, with flue spigot in place, into position under the flue and seal the spigot/flue connection with fire cement. (Ref. Fig. 6c).

It is recommended that a smoke test is performed inside the fire to ensure that adequate flue draw is evident.

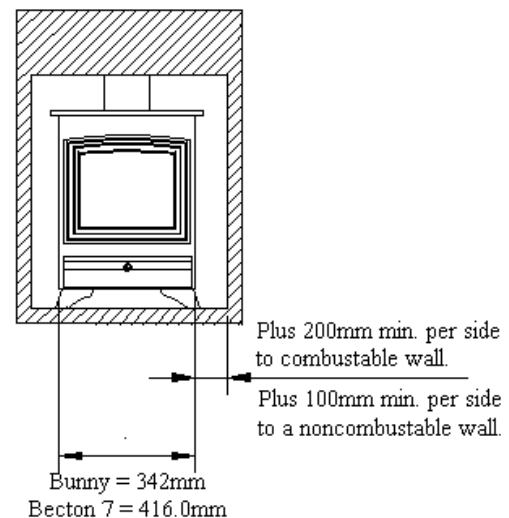

Fig 7a

INSTALLATION

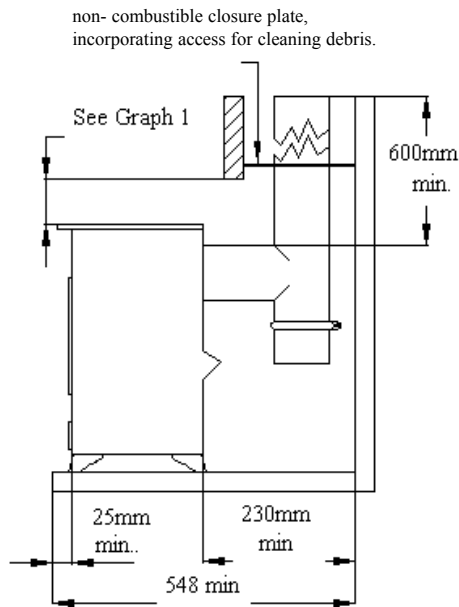

Fig. 7b.

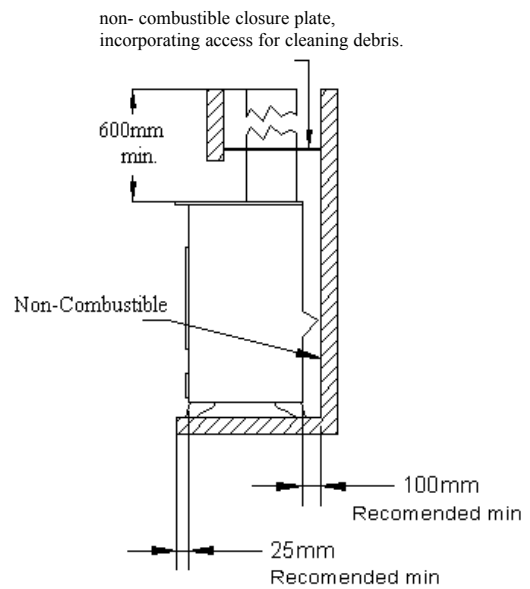

Fig. 7d.

FIRE LOCATION

The appliance must not be installed in a room or space, which contains a bath or shower.

This fire is designed for use with either top or rear flue outlets and must be mounted on a hearth with a minimum of 12mm non-combustible material thickness.

There must be a minimum of 200mm clearance from the sides of the fire to any combustible sidewalls. Fig 7a.

For clearance from the top of the fire to any combustible shelf. Fig 7b. (See Graph 1).

There must be a minimum of 230mm from the rear of the fire to any combustible back wall.

Fig 7b.

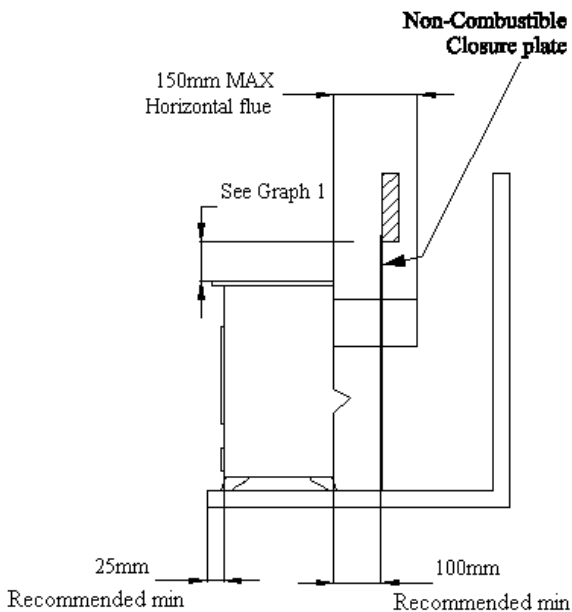

Fig. 7c

With a *Non-combustible* back wall the fire can be pushed back until the top diverter touches the wall, although to improve access and air circulation a minimum distance of 100 mm is recommended.

Fig 7c.

Reference non-combustible side walls a minimum of 100mm is recommended.

Do not place any furniture or furnishings (including curtains) within 1 metre of the fire.

The minimum height from the extreme top surface of the fire to the underside of a shelf or other projection made of wood or any other **combustible material** is shown on graph 1.

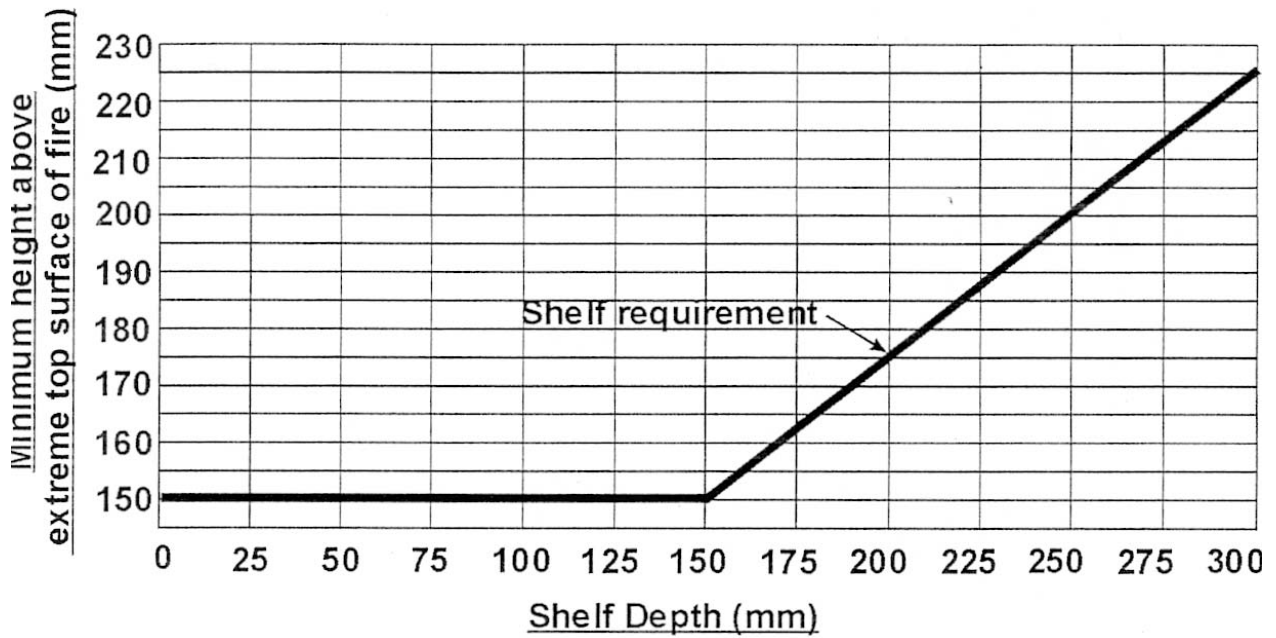

Graph 1. Combustible Shelf Clearances

The recommended minimum height from the extreme top surface of the fire to the underside of a **non combustible** shelf is 100mm.

INSTALLATION

HEARTH REQUIREMENTS

To comply with current Building Regulations the fire must stand on a fireproof hearth, which has an upper fireproof layer of 12mm non-combustible material. If the rear of the fire is to be pushed up against a surface it must be of a non-combustible material.

The hearth must protrude at least 25mm in front of the glass window and 150mm either side.

The hearth must not be capable of inadvertent covering by a carpet or rug. This should be achieved by either:

The hearth being 50mm above the level of the room floor. A 50mm high fender or kerb being fixed around the edge of the hearth.

CONNECTING THE GAS SUPPLY

Once the fire is in place it is then possible to connect the gas supply. The gas supply point is located at the rear of the appliance and should be connected in accordance with the following requirements.

Check that the appliance is suitable for the gas supply; refer to data labels on packaging and/or the fire for gas type. **Note: Natural gas and Propane (LPG) models are not interchangeable.**

The gas installation must be in accordance with the current issue of BS6891. Gas supply pressure at the fire should be 20mbar for natural gas.

The gas supply should be connected with the 1/4" BSP nut and olive with 8mm tubing.

A maximum pipe run of 1.5 meters (or 5 feet) should be adhered to and copper tubing may be used provided a distance of 25mm is maintained between pipe-work and any surface of the fire. A gas service cock should be fitted adjacent to the fireplace to enable safe removal of the appliance for servicing. After fitting the supply, operate the gas cock (supplied) and check all joints up to the termination of the supply pipe for gas tightness using a soap/water solution and the pressure drop method.

To check the pressure to the burner it is necessary to ignite the appliance and set to 'high rate'.

This is carried out by following instructions on pages 9 and 10.

Cold setting pressures are in the Technical data section on page 6.

The pressure test point is located through the hole in the valve bracket marked 'test point',

See Fig.8 below.

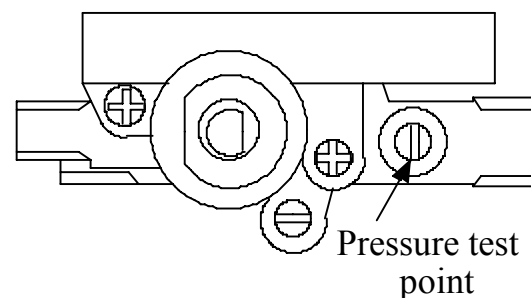

Fig. 8

TEST SEQUENCE

ENSURE FIRE IS OFF

1. Open control door.
2. Loosen test point screw.
3. Connect hose of test equipment to test point through the test point hole in bracket. (If necessary open fire door and remove coal set, base matrix plate and heatsheild. Close door on completion)
4. Turn on fire and set flame on high.
5. Take reading.
6. Turn fire off.
7. Remove test equipment hose.
8. Re-tighten test screw (If necessary replace heatsheild, matrix plate and coal set.

FIRE TESTING

Flame failure device testing

Step 1 Ignite the appliance in accordance with page 9 and run for 60 seconds.

Step 2 Turn the appliance off to extinguish the pilot, listen for a snap at the control valve. This should occur within 60 seconds of the pilot flame being extinguished. The snap sound will be the magnet disengaging, and thus shutting off the flow of gas to the pilot and burner.

Spillage Test

A qualified gas engineer should Perform a spillage test as follows:

Step 1. Close all doors and windows.

Step 2 Light the appliance and set to the high rate.

Step 3. Allow fire to warm up for 10 minutes.

Step 4. Position the smoke match at the back of the fire centrally beneath the draught diverter as shown in **Fig 9**.

All of the smoke should be drawn into the fire. If this does not occur the appliance must be disconnected and the flue checked.

***Step 5.* If there is an extractor fan in any room, this must be turned on and any doors between it and the fire left open, repeat the spillage test.**

Repeated operation of the spillage monitoring system indicates that there maybe a flue draw problem. In this situation no more attempts at operating the appliance should take place and your gas engineer should be contacted.

Warning: The spillage monitoring system is a safety feature required by law and must not be adjusted or put out of action by the installer. If the spillage monitoring system or any of its parts are to be replaced, only original manufacturers parts are to be used.

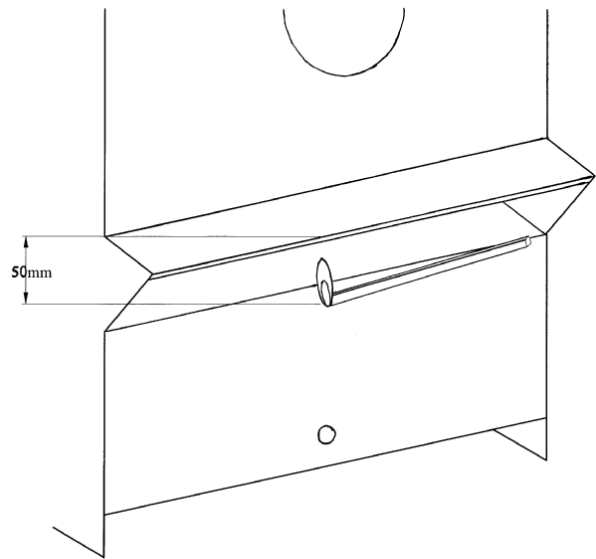

Fig. 9

Note: The fire will give off non-toxic fumes when first used. This is perfectly normal and is due to the paint curing, it will disappear after the first few hours. Once the spillage test is complete open windows and doors to ventilate the area.

INSTALLATION CHECK LIST

CHECKLIST

Hearths, Fireplaces, Flues and chimneys

This checklist is to ensure hearths, fireplaces, flues and chimneys are satisfactory, and to show what you have done to comply with the requirements of The Building Regulations 2000 Approved Document J 2002.

1. Building address, where work has been carried out.....	
2. Identification of hearth, fireplace chimney or flue	
3. Firing capability: solid fuel/gas/.	
4. Intended type of appliance. State model and output.	
5. Ventilation provisions for the appliance: State type and area of permanently open vents.	
6. Chimney or flue construction a) State the type or make and whether new or existing. b) internal flue size (and equivalent height, where calculated - natural draught gas appliances only). c) If clay or concrete flue liners used confirm that they are correctly jointed with socket end uppermost and state jointing materials used. d) If an existing chimney has been refurbished with a new liner, type or make of liner fitted. e) Details of flue outlet terminal and diagram reference. Outlet Details: Complies with: f) Number and angle of bends. g) Provision for cleaning and recommended frequency.	
7. Hearth. Form of construction. New or existing?	
8. Inspection and testing after completion Tests carried out by: Tests and results Flue inspection visual sweeping coring ball smoke Appliance (where included) spillage	
I/we the undersigned confirm that the above details are correct. In my opinion, these works comply with the relevant requirements in Part J of Schedule 1 to the Building regulations.	
Print name and title.....Profession.....	
Capacity.....Telephone.....	
Address.....Postcode.....	
Signed.....Date.....	
Registered membership of...(e.g. CORGI, OFTEC, HETAS, NACE, NACS).....	

DETAIL OF PILOT ASSEMBLY

It is strongly recommended to leave the pilot on permanently. This will keep the fire and its components, including the ceramic coal set in a warmer state and assist ignition to the burner.

This in turn will reduce condensation in the chimney and any associated flue problems.

The pilot can be viewed through the L/H & centre front slots in the base matrix.

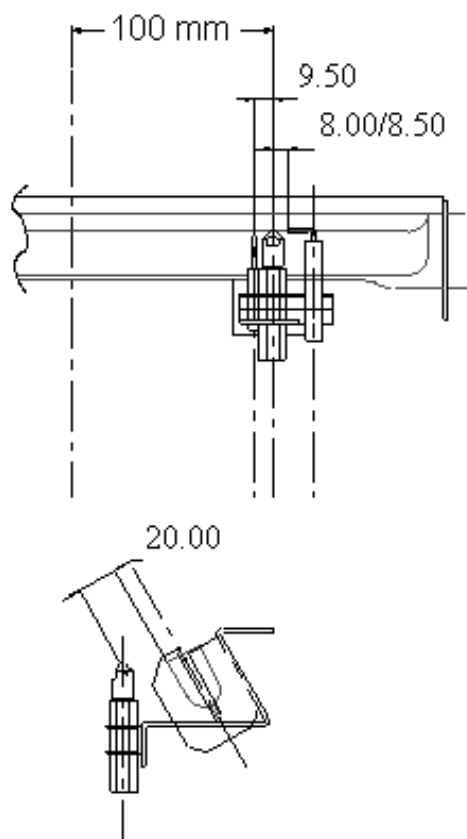

Fig. 10

SERVICING

DOOR TRIM

Becton Fire doors are fitted with a brushed steel finish trim as standard. The trim is secured using 3 off tabs and located in the slot section of the trim and secured with 3 off nuts. (See Fig. 11a below.)



Fig. 11a Location of the 3 off tabs

Note! To fit a tracery the trim must first be removed. The fire door can only be fitted with one item at a time.

REPLACEMENT OF THE DOOR TRIM

Ensure the appliance is cold.

Step 1 Remove the fire door.

This is carried out by opening the door (secured with a magnet) and lifting it off its hinges.



Fig 11b Lifting the door off its hinges

Step 2 Place the door on a flat surface and remove the single tab. The tracery can now be removed. (See Fig. 11c below)



Fig. 11c Untightening the single tab

Step 3 The trim will now lift off the remaining 2 tabs. See Fig. 11d.



Fig 11d

Step 4 Repeat the above steps in reverse to replace the trim.

FIRE DOOR GLASS & SEAL

If necessary the glass and seal can be removed as follows:

Ensure the appliance is cold.

Step 1 Open the fire door.

Step 2 The glass frame is secured using M5 screws. Remove all but the bottom 2 screws. See Fig. 12 below.



Fig. 12 Removing the Glass Frame

Step 3 Loosen the two remaining screws to enable you to lift off the glass frame and the glass and gasket assembly together.

To re-fit the glass & seal. First ensure sealing faces are clean and free from dust. Then follow the removal steps in reverse.

Note! The screws must be firmly secured to reform the seal.

BURNER ASSEMBLY

To remove the burner assembly proceed as follows;

Ensure the appliance is cold.

- Step 1* Turn off the gas supply at the gas service cock.
- Step 2* Disconnect the supply inlet pipe at the rear of the fire.
- Step 3* Open door and remove the glass frame and glass gasket assembly.
- Step 4* Remove the coal set and fire box linings.
- Step 5* Remove the matrix location plate. Undo the three retaining nuts and lift out.
- Step 6* Remove the heat shield. Undo the two retaining nuts located on the left hand side of the shield. Slide the shield backwards and lift out carefully. Do not damage the covering.
- Step 7* Remove the gas valve control knob. Pull off.
- Step 8* Remove the 15mm retaining flange nut. 17mm socket.
- Step 9* Remove two off posi-drive screws just inside the fire door aperture.

The burner assembly will now lift out.

After replacement of burner assembly, ensure that a check on the gas tightness of any new joint is carried out.

REGULAR SERVICE

See "SAFETY NOTICES" ref coal set page 4.

Any soot debris should be removed from the fuel bed regularly by the end user.

Ensure the appliance is cold.

- Step 1* Isolate the gas supply from the fire.
- Step 2* Open the fire door and remove the glass frame and the glass/gasket assembly (Note the fire door is secured with a magnet).
- Step 3* Carefully remove and clean the coal set of any soot deposits with a soft a brush.
- Step 4* Remove any soot deposits from inside the fire using a vacuum cleaner. (See "Safety Notices" under 'Coal set' on page 4).
- Step 5* Replace the coal set. See assembly procedure on page
- Step 6* Replace glass/gasket assembly and glass frame.
- Step 7* Close fire door.

SERVICING

ANNUAL SERVICE

THIS GAS APPLIANCE MUST BE SERVICED EVERY TWELVE MONTHS BY A QUALIFIED GAS ENGINEER.

See "SAFETY NOTICES" ref coal set page 4.

Ensure the appliance is cold.

- Step 1* Isolate the gas supply to the fire using the gas cock supplied at installation.
- Step 2* Open the fire door, (Held closed using a magnet).
- Step 3* Remove the glass frame and the glass/gasket assembly.
- Step 4* Carefully remove and clean the coal set of any soot deposits using a soft brush.
- Step 5* Carefully remove and clean the firebox linings. Where necessary.
- Step 6* Inspect the chimney and flue terminal ensuring they are in good working order and sweep as necessary to ensure no debris blocks the flue. Please note periodic chimney sweeping is vital to gas fire maintenance.
- Step 7* Remove matrix location plate and valve heat shield. Clean any soot deposits from inside the fire using a vacuum cleaner. See "Safety notes" on page 4.
- Step 8* Inspect the pilot assembly to ensure that it is clean, unobstructed and in good order.
- Step 9* Check system for gas soundness.
- Step 10* Replace heat shield and matrix location plate.
- Step 11* Replace fire box linings.
- Step 12* Replace coal set.

Step 13 Replace glass/gasket and glass frame and close the fire door.

Step 14 Carry out spillage test as per instructions on page 16.

CLEANING OUTER SURFACES

To clean the outside first the appliance must be cold.

The outside finish of the fire is a durable high temperature paint, this will give off a slight odour during the first few days of operation. It is best cleaned by using a soft brush. Do not allow moisture to remain on the fire whilst cold or surface rust may occur.

CLEANING THE GLASS

To clean the glass the appliance must be cold.

Step 1 Open the fire door. (This is held closed using a magnet)

Step 2 Remove the glass frame and the glass/gasket assembly (See page 19).

Take care not to damage the glass or gasket when cleaning.

Step 3 Replace glass frame and the glass/gasket assembly. Close the fire door.

SERVICING

FAULT DIAGNOSIS

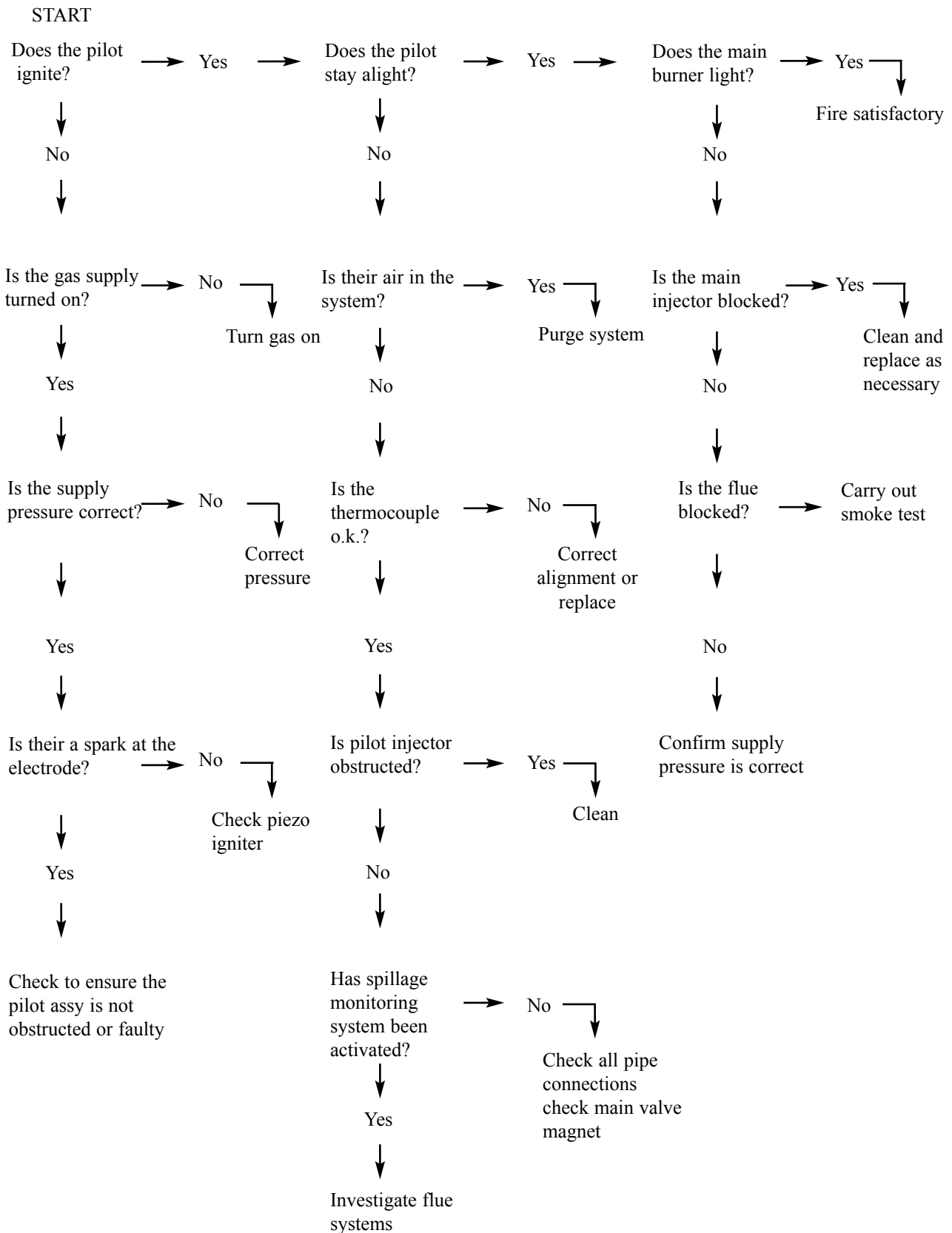

SPARE PARTS

GENERAL COMPONENTS

Spare parts can be obtained by contacting the original supplier of the fire or Aarrow Fires.

Fire Body Ancillary Components.
Only use genuine Aarrow parts.

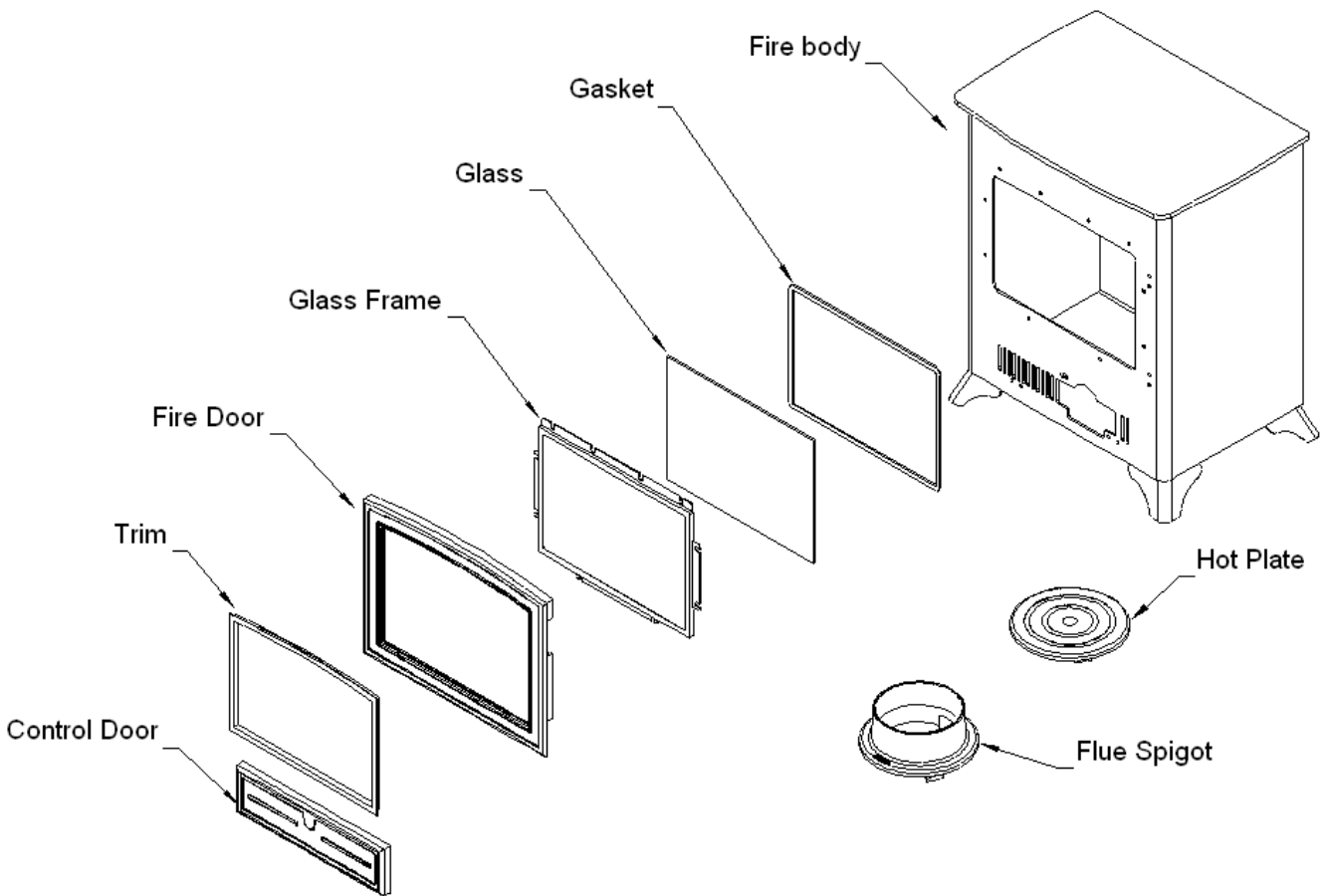

ACCESSORIES AND OPTIONS

Paint- Matching aerosol paint to tone in any connecting flues, pipes or surrounding metalwork

Tracery or Trim - Note: When fitted one replaces the other.





Add on Canopies

Bunny - Low available only
Size: 400mm wide x 345mm deep.
Raises the stove approximately 140mm.



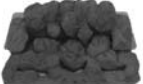

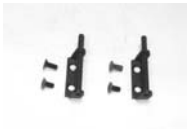

Becton 7 - High and low are available.
Size:-480mm wide x 345mm deep
High. Raises the stove approximately 240mm
Low. Raises the fire approximately 180mm.

NOTES





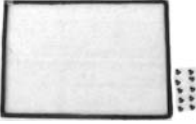



SPARE PARTS

Part Description	Visual Aid (not to scale)	Bunny mk3 Part No.	Becton 7 mk3 Part No.
1. Becton 7 mk3 Coal Set		-	AFGS1075
1a. Becton Bunny mk3 Coal Set		AFGS1074	-
2. Co-pilot assembly		AFGS089	AFGS089
3. Elbow Injector		AFGS090	AFGS090
4. Gas Control Valve		AFGS091A	AFGS091
5. Magnetic Catch for mk3 Gas Fires.		AFGS1073	AFGS1073
6. Hinge Kit To Fit Either Door. Comprises 2 Hinges & 4 Fixings Per Set.		AFS047	AFS047

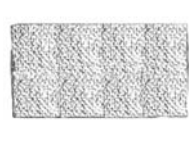
SPARE PARTS

Part Description	Visual Aid (not to scale)	Bunny mk3 Part No.	Becton 7 mk3 Part No.
7. Control Door Handle Assembly		AFGS1085	AFGS1085
8. Burner & Fixing		AFGS1076	AFGS1077
9. Pipe Set Complete With Connectors		AFGS080	AFGS080
10. Decorative Door Surround (Trim)		AFS094A	AFS095
11. Fire Door Assembly complete with Magnet Lock and Trim		AFGS1078	AFGS1079
12. Glass Replacement Kit with Gasket & Fixings.		AFGS1080	AFGS1081
13. Hotplate		AFGS064	AFGS010
14. Flue Outlet Spigot		AFGS1082	AFGS1083

SPARE PARTS

Part Description	Visual Aid (not to scale)	Bunny mk3 Part No.	Becton 7 mk3 Part No.
15. Becton 7 mk3 Lining Kit		-	AFGS1072
16. Large Ceramic Panel		AFGS093	AFGS093
17. Medium Ceramic Panel		AFGS094	AFGS094
18. Small Ceramic Panel		AFGS1084	AFGS1084
19. Gas Tap		AFGS025	AFGS025
20. Manual		AFS1125	AFS1125
21. Feet and Fixings		AFS1013	AFS1013
22. Arrow Fires Gauntlet Gloves		AFS997	AFS997

GUARANTEE

Once again we would like to thank you for buying a Becton fire.

When you buy an **Arrow Fire**, you are not only buying a first class appliance - you are buying a commitment from us to look after you and your appliance.

The Becton Gas Stoves come with a ***Lifetime Guarantee*** against splitting or cracking of the main body. The main body being defined as the steel outer casing and items fixed immovably to the casing. All other parts are covered by a one-year no-quibble parts Guarantee.

This Guarantee shall not apply to any part that has been altered in any way, or which in our judgment has been subjected to misuse, neglect, accident, abuse and fair wear and tear.

This Guarantee shall not include or extend to paint, glass or coal matrix and does not cover installation and operational related problems such as use of unapproved fuel, down draft or spillage caused by environmental conditions and inadequate ventilation.

Claims are not valid where the installation does not conform to local Building Regulations.

The Guarantee is conditional upon the appliance being serviced and checked annually by a qualified gas engineer.

The Manufacturers decision shall be final.

If your appliance proves to be defective as a result of faulty materials or workmanship during guarantee, we will repair or replace it FREE OF CHARGE as long as the fire has been installed according to these instructions and by a CORGI Registered fitter, who has completed and signed the Installation Check List on page 17. The fire must also be serviced in accordance with these instructions and the record of Annual service on page 30 should be completed by your service engineer.

All Guarantee periods commence on the date of purchase and are non-transferable.

Our Lifetime Guarantee is offered as an addition to your statutory rights.

If you think your fire is not working correctly or in the event of a breakdown, **please call your local dealer.**

When you contact them, they will want to know:

1. Your Name, Address/Post Code and Telephone Number
2. Serial Number
3. Clear and concise details of the fault

CUSTOMER REGISTRATION

See card enclosed

To guarantee the very best in after-sales service, do not forget to complete and return your Customer Registration Card within 14 days (a stamp is required).

Just complete the form and return it to us to:

1. Benefit from our *Lifetime Guarantee*.
2. Register your appliance for a full year's Parts Guarantee.

Please contact us direct 01308 427234 if no Customer Registration Card is included.

SERVICE RECORD

Date of Visit	Company	Work Carried Out	Signature

Should you have any questions about your Becton Gas Stove that is not covered in this manual please contact your Arrow retailer.

Please keep all repair receipts safely.

Please ensure you have this manual available when an engineer visits as they will complete the service record chart.



Lifetime Guarantee

For your peace of mind

Aarrow Fires gives a Lifetime Guarantee against manufacturing defects of the main body* of its Becton range of fires. Additionally, all other parts are covered by a one year no quibble replacement guarantee. This guarantee covers replacement of the item only and does not extend to any other costs, including labour, incurred in its replacement. Documentation must be retained and produced in the event of a warranty claim. This guarantee specifically does not cover accidental damage, misuse, wear & tear. The use of non Aarrow replacement parts will invalidate your warranty. For full details contact your local Aarrow dealer. All guarantees are in addition to your statutory rights. Please see page 29 for further information regarding the guarantee.

*The main body defined as the steel outer casing and items fixed immovably on to this casing.

No fears and no tears with

The **Becton**
Family

FINAL FACTORY CHECK LIST

Model.....
Serial No.....

QUALITY	
FINISH	
COAL SET	
REGISTRATION CARD	
LINING SET	
FLUE OUTLET	
HOTPLATE	
OPERATING INSTRUCTIONS	
GAS COCK	
FEET & FIXINGS	

***I've checked it
and it's O.K.***

Assembled by.....

Checked by

Please ensure the enclosed registration card is completed and returned to Aarrow Fires and the following information completed for your own information.

Date of Purchase.....

Name and address of supplier.....

.....
.....

**** Please ensure installer completes INSTALLATION CHECK LIST details
on page 17 of this manual.***