



### Product features:

- Metal construction throughout
- Single spray pattern showerhead
- Swivel showerhead connector for maximum flexibility
- The perfect combination of European design styles

### Packaged properties:

**Box length:** mm      **Box depth:** mm  
**Box width:** mm      **Boxed weight:** 2.25 kg

**Includes pop up waste?:** No

**Additional comments:**  
 See AB2416 & AB2408

### Product dimensions:

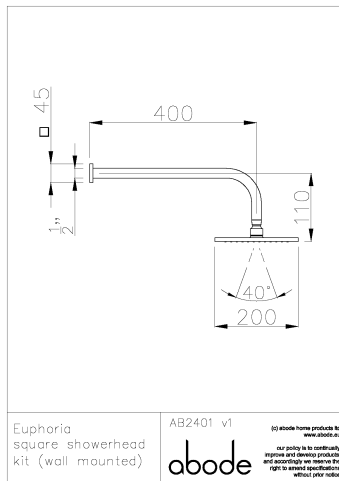

- **Overall Height / projection:** 500 mm
- **Exit reach:** 400 mm
- **Exit height:** 110 mm
- **Centre distance(s):**
- **Base diameter(s):** 45 mm
- **Product mounted where:** Wall
- **Recommended hole diameter:**
- **Min. fitting depth required:**
- **Max. surface depth:**

### Product flow characteristics:

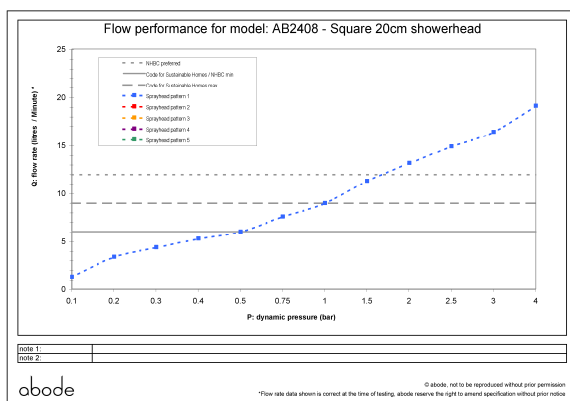

- **Min / Max water pressure:** 0.40 / 5 bar
- **Part G mixed flow rate at 3 bar (l/m):** 16.4
- **Max water temperature:** 70° C
- **Product flow characteristics:**
- **Aerator type:**
- **Includes output diverter?:** No
- **Control valve type:** ( )
- **Non return valve position:**
- **Mesh particle filter size:**
- **Inlet / outlet size:** 1/2" F / 1/2" M
- **Inlet type / length:** Fixed / mm
- **Shower hose type / length:**

### Warranty Summary (Full details available on request):

- Materials and workmanship defects warranted for 5 years
- Valves and working parts warranted for 2 years
- Surface warranty defects warranted for 1 year
- O-rings, hoses & gaskets warranted for 1 year

### Care instructions:

- Clean the mixers and showers regularly as required, using soap, do not use any other cleaners.
- Regular cleaning will prevent the build up of lime scale and dirt
- After cleaning rinse thoroughly with clean water to remove any cleaner residue
- Residues of liquid soaps, shampoos and shower foams can also cause damage, so rinse with clean water after using, avoid contact with any abrasives