

Product features:

- Metal construction throughout
- Rub clean anti limescale spray nozzles
- Single spray pattern showerhead
- Minimalist planate design form
- 5 year limited warranty



Packaged properties:

Box length: 340 mm **Box depth:** 80 mm
Box width: 330 mm **Boxed weight:** 2.16 kg

Includes pop up waste?: No

Additional comments:
 122 Nozzles, includes mesh filter washers

Product dimensions:

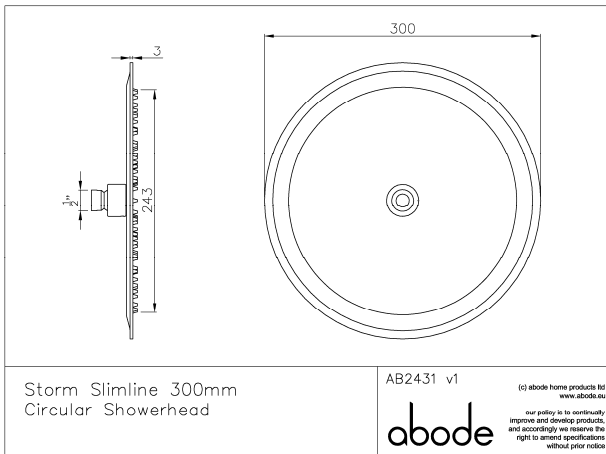

- **Overall Height / projection:** 45 mm
- **Exit reach:**
- **Exit height:**
- **Centre distance(s):**
- **Base diameter(s):**
- **Product mounted where:** Roof / wall
- **Recommended hole diameter:**
- **Min. fitting depth required:**
- **Max. surface depth:**

Product flow characteristics:

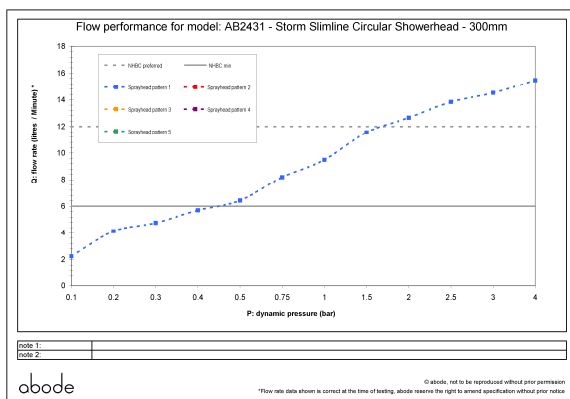

- **Min / Max water pressure:** 0.40 / 5 bar
- **Part G mixed flow rate at 3 bar (l/m):** 14.52
- **Max water temperature:** 70° C
- **Product flow characteristics:**
- **Aerator type:**
- **Includes output diverter?:** No
- **Control valve type:** ()
- **Non return valve position:**
- **Mesh particle filter size:** 0.60 mm
- **Inlet / outlet size:** 1/2" F /
- **Inlet type / length:** Fixed / mm
- **Shower hose type / length:**

Warranty Summary (Full details available on request):

- Materials and workmanship defects warranted for 5 years
- Valves and working parts warranted for 2 years
- Surface warranty defects warranted for 1 year
- O-rings, hoses & gaskets warranted for 1 year

Care instructions:

- Clean the mixers and showers regularly as required, using soap, do not use any other cleaners.
- Regular cleaning will prevent the build up of lime scale and dirt
- After cleaning rinse thoroughly with clean water to remove any cleaner residue
- Residues of liquid soaps, shampoos and shower foams can also cause damage, so rinse with clean water after using, avoid contact with any abrasives