

BRB2617
**Built-in combi frost
free fridge/freezer**

INSTRUCTION MANUAL

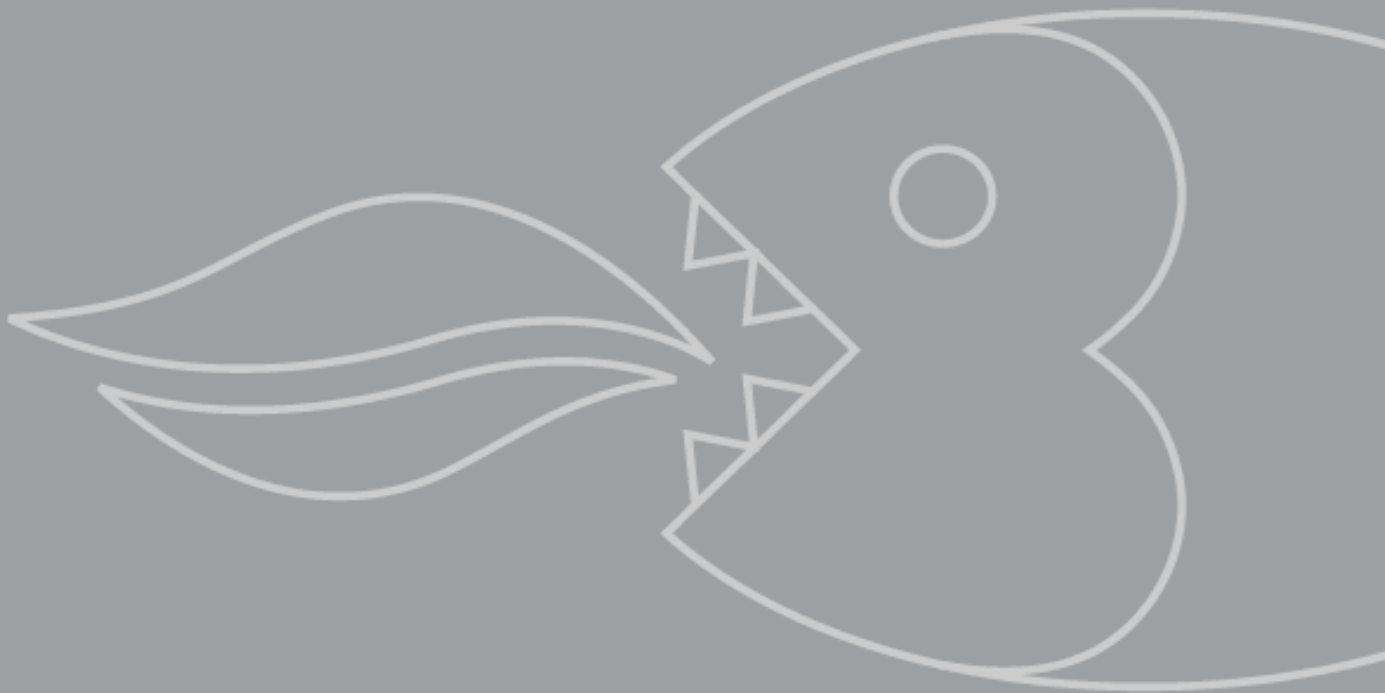

USER MANUAL FOR YOUR BAUMATIC



BRB2617

Built-in combi frost free fridge/freezer



NOTE: This User Instruction Manual contains important information, including safety & installation points, which will enable you to get the most out of your appliance. Please keep it in a safe place so that it is easily available for future reference, for you or any person not familiar with the operation of the appliance.

Contents

Environmental note	4
Important safety information	5 – 6
Specifications of your combi fridge freezer	7 -10
Description of your appliance	8
Control panel	9
Description of the product features	9-10
Using your Baumatic combi fridge freezer	10-12
Before switching on	10
During first use	11
Switching on the appliance and setting the thermostat	11-12
Arranging and storing food in the fridge section	12-13
The  freezer compartment	13-16
Freezing fresh food	14
Tips on freezing	15
Making ice cubes	15
Warning alarm	16
Saving energy when using your fridge-freezer	17-18
Cleaning and maintenance	18-21
The defrost drain hole	19
Defrosting the  freezer compartment	20-21
Replacing the light bulb	21
Installation	22-35
Electrical connection	22
Positioning	23
Reversing the doors of your appliance	24-30
Aperture dimensions and ventilation requirements	30-31
Installing your fridge freezer	32-35
Troubleshooting	36-37
Baumatic consumables	38
Technical data	39
Contact details	40

Environmental note

Note: Before discarding an old appliance, switch off and disconnect it from the power supply. Cut off and render any plug useless. Cut the cable off directly behind the appliance to prevent misuse. This should be undertaken by a competent person. Disable the door lock to make sure that children cannot get stuck inside the appliance.

This appliance is marked according to the European directive 2002/96/EC on Waste electrical and Electronic Equipment (WEEE). By ensuring this product is disposed of correctly, you will help prevent potential negative consequences for the environment and human health, which could otherwise be caused by inappropriate waste handling of this product.

The symbol  on the product, or on the documents accompanying the product, indicates that this appliance may not be treated as household waste. Instead it shall be handed over to the applicable collection point for the recycling of electrical and electronic equipment.

Disposal must be carried out in accordance with local environmental regulations for waste disposal.

For more detailed information about treatment, recovery and recycling of this product, please contact your local city office, your household waste disposal service or the shop where you purchased the product.



Important safety information



Your safety is of the utmost importance to Baumatic. Please make sure that you read this instruction booklet **before** attempting to install or use the appliance. If you are unsure of any of the information contained in this booklet, please contact the Baumatic Advice Line.

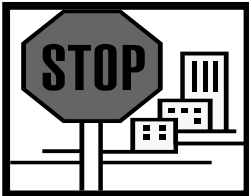

IMPORTANT: Any installation work must be carried out by a qualified electrician or competent person.

Use of the appliance

- Your appliance is only designed to be used in the home. It is suitable for storing food that needs to be chilled and refrigerated. If it is used for any other purpose or it is not used correctly, then Baumatic Ltd. will accept no liability for any damage that may be caused.
- Altering the specification of the appliance must not be attempted for reasons of safety.



Before using your appliance

- Check the appliance for any signs of transport damage. If you notice any damage, then you should not connect your appliance to your mains supply and should contact your retailer.

Refrigerant

- Your appliance contains R600a refrigerant, which is a natural gas that does not contain CFCs that can damage the environment. However it is a flammable substance, therefore care should be taken:
 - During the transportation and installation of the appliance, make sure that the refrigeration pipework does not get damaged.
 - If it does become damaged then sources of ignition and open flames should be avoided. Also the room that the appliance is situated in should be thoroughly ventilated.
- Do not place any objects on top of the appliance, as this may damage the table top.



Child safety

- Packaging material should be kept away from children.
- Children should not be allowed to touch the controls or play with the appliance.



General safety

- Do not pull on the power supply cable to remove the plug from your mains supply socket.
- Do not pull out or insert the plug with wet hands.
- Do not attempt to use your appliance outdoors or any place where it is likely to come into contact with the elements.
- Before cleaning the appliance or performing maintenance work, ensure that the appliance has been disconnected from your mains supply.
- Never allow the back coils of the appliance to come into contact with the wall surface.
- Always ensure that the location where you are installing your appliance is free of stored items such as papers and other flammable materials.
- Never block the ventilation openings of the appliance, either on the inside or its exterior.

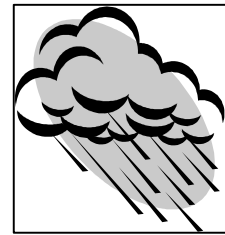

It is vital to keep your appliance well ventilated, so that there is proper air flow between the bottom of the unit and the plinth/kick plate which it is sitting on. See the ventilation instructions on page 30 of this manual.

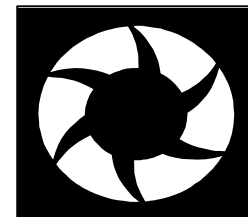

- Do not place electrical devices inside of the appliance, such as mixers and electric ice cream makers.

Service

You should not attempt to repair the appliance yourself, as this could cause injury or a more serious malfunction. If you require a service call then please contact the Baumatic Service Department.

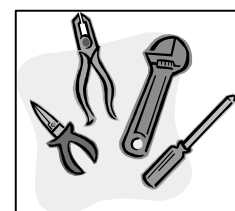

Specifications of your BRB2617 fridge freezer

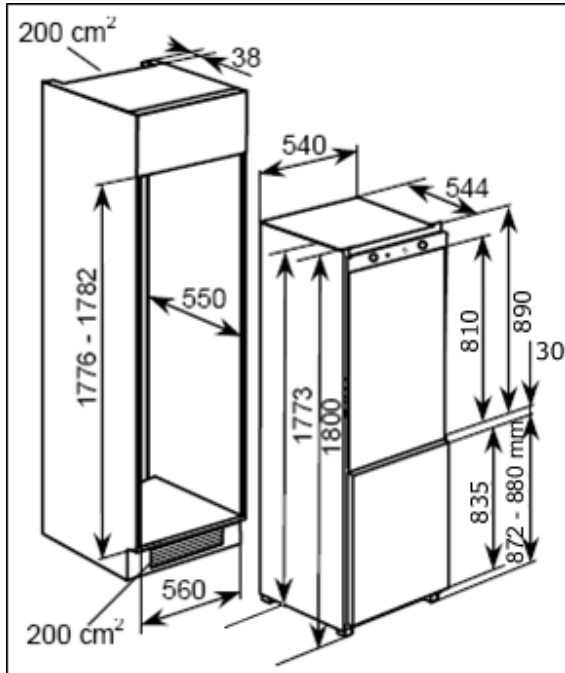

Dimensions of appliance

Height: 1773 mm
Width: 540 mm
Depth: 544 mm

Dimensions of aperture*

Height: 1776 mm – 1782 mm
Width: 560 mm
Depth: 550 mm

- Automatic fridge defrost
- Frost free freezer
- Adjustable thermostat
- Egg rack
- Butter compartment
- Bottle rack
- 2 General racks
- 4 Safety glass shelves (including salad crisper cover)
- 2 salad crispers
- 4 Freezer drawers
- Ice cube tray
- Reversible door
- Slider fittings
- Adjustable feet
- 4 star freezer
- Freezing capacity: 4 kg / 24 hours

Cubic capacities

- Total gross / net capacity: 262 / 249 litres
- Gross fridge / freezer capacity: 162 / 100 litres
- Net fridge / freezer capacity: 158/91 litres (without baskets)

Energy efficiency class

Energy class: A

* Please refer to the installation instructions for more specific information on the size of aperture that you will require.

IMPORTANT: When you install your appliance it is important to bear in mind its climatic rating.

In order to find out the climatic rating of your appliance, you should check the rating plate. The rating plate is located on the front left edge of the inside of the fridge section. You will need to open the fridge door of your appliance to be able to find it. The rating plate will indicate the ambient temperature range that your appliance will function correctly within.

Description of the BRB2617 fridge freezer

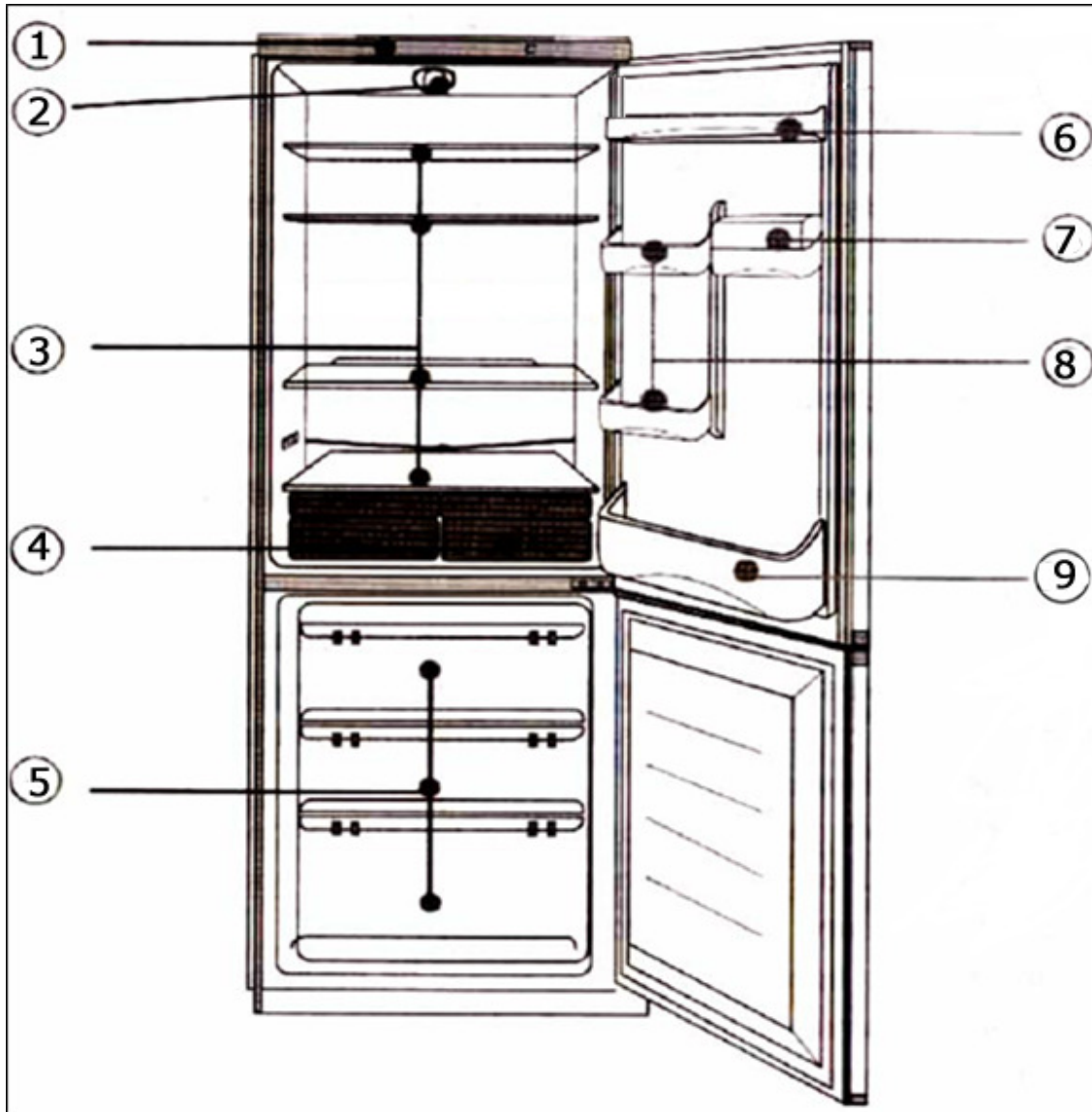

1. Control panel
2. Fridge light
3. Safety glass shelves (x 4)
4. Salad crisper drawers
5. Freezer drawers

6. Fridge door shelf
7. Half width door shelf cover
8. Half width door shelves
9. Bottle shelf

Control panel

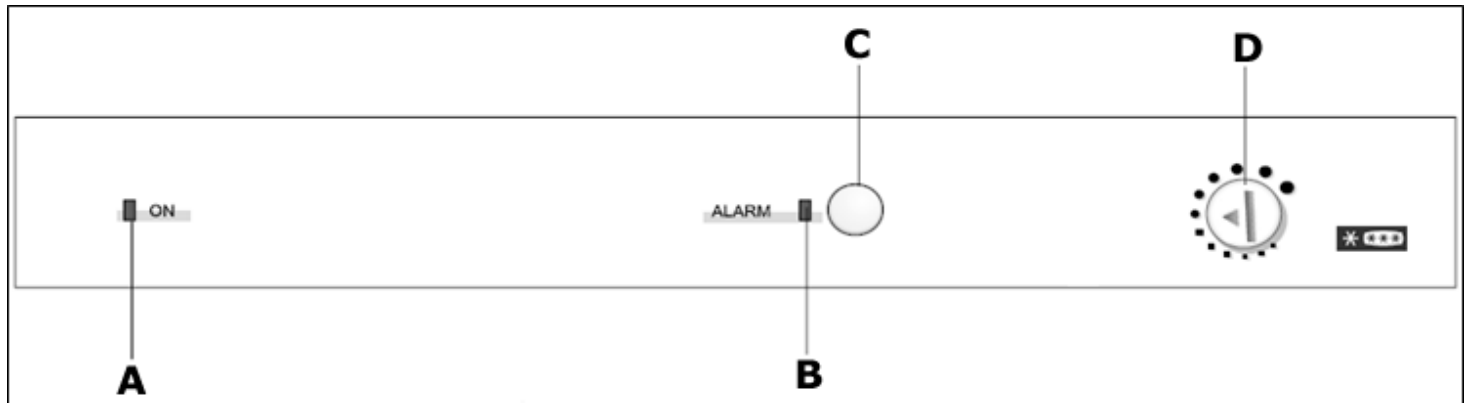

- A) Power indicator neon (green)
- B) Warning alarm neon (red)
- C) Warning alarm off button
- D) Fridge freezer thermostat dial

Power indicator neon (green)

- This will light as soon as the appliance is connected to your mains supply.

Warning alarm neon (red)

- This neon will light if the warning alarm has activated.

Description of the product features

1) Safety glass shelves

- The shelves may be placed in any of the guide slots within the interior of the appliance. They are protected from sliding out.
- To remove a shelf: Take off all of the items that are stored on the shelf that you want to remove. Then lift the front of the shelf and carefully pull it out of the grooves.

2) Defrost water outlet

- The interior of the refrigerator is cooled by the cooling plate that is on the rear wall. Beneath this there is a channel and an outlet for the defrost water.
- It is important that this channel never becomes clogged (see "The defrost drain hole" section for a detailed explanation of how to keep the channel clear).

3) Salad crisper drawers and cover

- The crisper drawers are in the bottom of your refrigerator and there is a cover that goes over them.
- The cover helps to prevent fruit and vegetables from drying out prematurely.

4) Upper and half width door shelves

- The door liner holds various shelves, which are suitable for storing eggs, cheese, butter and yogurt. As well as smaller packages, tubes, cans etc.

5) Bottle shelf

- The lower shelf should be used for storing reasonably sized bottles.
- **IMPORTANT: IT IS IMPORTANT THAT NONE OF THE SHELVES THAT SIT IN THE DOOR ARE OVERLOADED, AS THIS WILL DRASTICALLY REDUCE THEIR WORKING LIFE.**

6) Freezer compartment

- A ❄️ freezer section, with a net capacity of 91 litres.

Using your Baumatic combi fridge freezer

Before switching on

- Make sure that it has been installed by a suitably qualified person, as per the information contained in Baumatic's installation instructions.
- After delivery, wait for eight hours before connecting the appliance to your mains supply. This will allow any refrigerant gasses that may have been disturbed during the transportation process to settle.
- The outside of the appliance and the removable accessories contained within it, should be cleaned with a solution of liquid detergent and water.
- The interior of the appliance should be cleaned with a solution of sodium bicarbonate dissolved in lukewarm water. The interior and accessories should be thoroughly dried, after the cleaning process has been completed.
- There can be an odour when you first switch on the appliance. It will lessen as the appliance starts to cool.

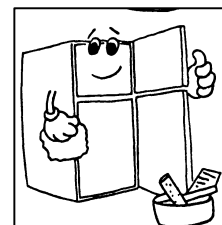

During first use

- You should set the thermostat dial to its maximum setting for 24 hours after switching on the appliance for the first time.
- When you first switch on the appliance, the compressor will run continuously for approximately 24 hours or until the fridge freezer reaches a cool enough temperature.
- During this period of time, you should try not to open the door frequently or place a large amount of food within the appliance.
- You should then adjust the thermostat dial down to its normal operating position.
- If the unit is switched off or unplugged, you must allow at least 5 minutes before restarting the appliance on the thermostat or connecting it to your mains supply.

Switching on the appliance and setting the thermostat

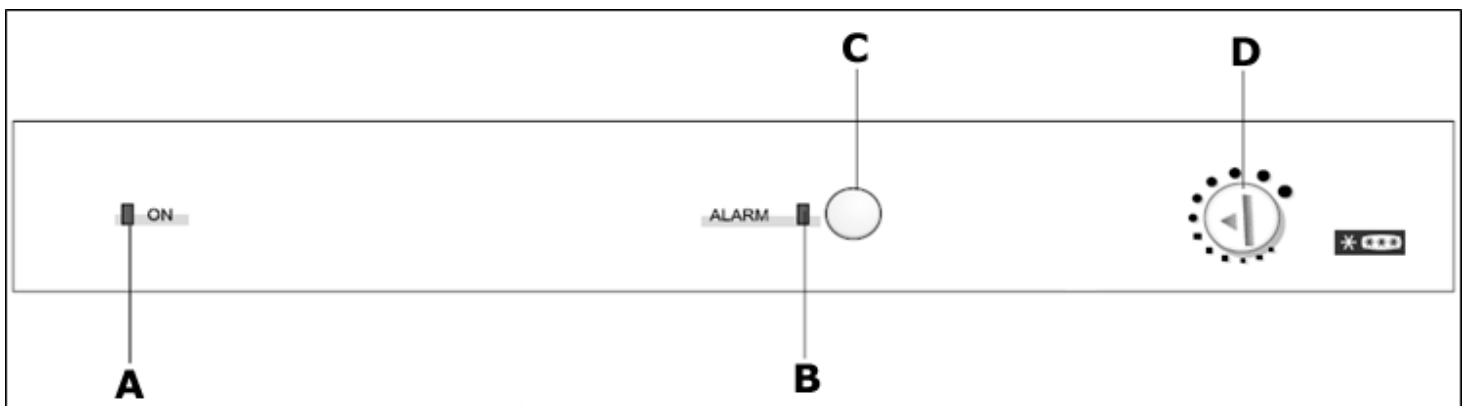

You switch on your appliance by connecting it to your mains supply and setting the thermostat. The thermostat dial is located on the control panel, which can be found at the top of the fridge freezer.

- The thermostat automatically regulates the temperature inside the fridge freezer, depending on which setting you have turned the thermostat dial to.
- You should turn the thermostat dial clockwise.
- If the arrow is positioned to the smaller dots, then you will get a higher temperature inside the fridge and freezer sections.
- If the arrow is positioned to the larger dots, then you will get a lower temperature inside the fridge and freezer sections.



- Ideally the arrow should be set to the midway position (as shown in the diagram opposite).

- Your refrigerator can maintain a temperature of between 4 – 6 degrees centigrade.
- The freezer section can cool down to -18 degrees centigrade and lower.

- **IMPORTANT:** *The ambient temperature of the room, the temperature of food and the amount of food that has been placed in the appliance and how often the door is opened, will all affect the temperature being maintained by the appliance.*

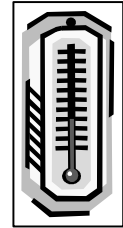

- On the maximum setting (shown opposite) your fridge freezer will work harder to maintain a lower temperature and will increase the energy usage. There is no need to run your appliance at this setting for prolonged periods. Unless you are freezing fresh food, you should have the dial set in the position shown above.

- **IMPORTANT:** *If you run the appliance with the thermostat dial on a higher setting for prolonged periods, the defrost drain hole will freeze. It may also cause the appliance to overwork and the fridge and freezer sections to freeze over.*

Arranging and storing food in the fridge section

- Warm food or evaporating liquids should not be stored in your refrigerator, as this will increase the humidity inside of the appliance.
- All foods should be wrapped or covered, this is particularly important if the food has a strong flavour. You should use polythene bags or sheets, aluminium foil, wax paper. Liquids should be stored in covered containers or bottles.
- To maximise the space inside of the fridge section, any excessive packaging on the food should be removed.
- Quickly perishable food should be stored at the back of the refrigerator, which is the coldest part of the appliance.

- No food items should be allowed to come into contact with the back wall of the refrigerator.
- Make sure that you arrange food in such a way that the door can close completely. Particular attention should be given to bottles that may protrude when placed on shelves inside the main section of the refrigerator.
- Some organic solutions, such as the oils in lemon/orange peel and acid in butter, can cause damage to the plastic parts contained inside of the refrigerator.
- Do not open the refrigerator door too often or leave the door open for long periods of time, as this will increase the temperature inside of the appliance and will increase the energy usage.
- **Meat** should be wrapped in polythene bags and then placed on the glass shelf above the salad drawers.

(Meat should only be stored in this manner for one or two days at the most).

- **Cold dishes/cooked food** should be covered and can be placed on any shelf.
- **Fruit and vegetables** should be cleaned thoroughly and placed in the salad drawers.
- **Cheese and butter** should be placed in airtight containers, or they can be wrapped in aluminium foil or polythene bags. As much air as possible should be removed from the bags.
- **Milk bottles** should have a cap on them and be stored on the bottle shelf that sits in the door.
- **Garlic, potatoes, onions and bananas should only be stored in a refrigerator IF they are stored in airtight containers.**

The freezer compartment

The freezer compartment is suitable for storing and freezing food.

- The freezer compartment temperature must have already reached -18 degrees centigrade (or lower) before you attempt to store food that is already frozen or freezing fresh food.
- The freezer compartment is only able to freeze a certain quantity of food at one time. The maximum amount of fresh food that can be frozen within a 24 hour period is 4 kg. You should not attempt to freeze more than this amount of fresh food within a 24 hour period.
- Warm food should be allowed to cool down before you attempt to freeze it. If you place warm food in the freezer compartment, then the increased humidity will cause quicker ice formation and increase the amount of power that the appliance uses.
- The guidance of the food manufacturer should be followed, in regard to the maximum storage time.
- Thawed foods must not be frozen for a second time.
- It is possible to store food in the freezer section without the baskets supplied.
- If power is cut to the appliance, then the food inside of it will be safe for a maximum of 12 hours. You should minimise the number of times that you open the doors of the appliance during this period of time.

Freezing fresh food



- To freeze the maximum quantity of fresh food specified on the rating plate, you should turn the thermostat dial to its maximum position (shown opposite), a few hours prior to attempting freezing.
- For smaller quantities of fresh food, you should turn the thermostat dial to its maximum position, 1 hour prior to freezing.



- Fresh food should be packed into airtight containers or packaging. This will help to make sure that the food doesn't dry out or lose its flavour. It will also ensure that flavour does not transfer from other foods.



- After 24 hours you should check that the fresh food is satisfactorily frozen. If it is then the thermostat dial should be turned back to its normal operating position.

- **IMPORTANT:** *If you run the appliance with the thermostat dial on a higher setting for prolonged periods, the defrost drain hole will freeze. It may also cause the appliance to overwork and the fridge and freezer sections to freeze over.*

Tips on freezing

- Freezer bags, polythene wraps, aluminium foil (extra thick) and special cans for frozen foods are suitable packaging for storing frozen goods in.
- Tape, rubber bands or plastic clips are suitable for sealing bags and wrappings.
- Before sealing a suitable bag, you should compress the air out of it, as this will help the food to freeze more easily.
- Flat packages freeze more easily.

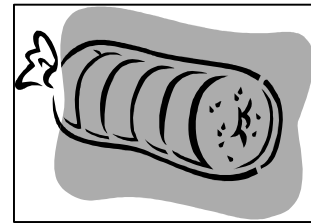

- If you are freezing liquid, then do not fill the container to the brim. Liquids will expand when being frozen.
- **Do not place bottles (glass or tin) containing liquids (especially sparkling liquids) into the freezer as they could cause the bottle to burst during freezing.**

Making ice cubes

- Fill the ice cube tray with water and place it in the freezer compartment.
- After the water is completely frozen and turned to ice, you can twist the ice cube tray (as shown in the drawing below) to dispense the ice.

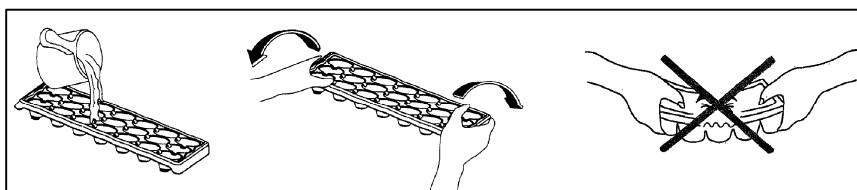

Warning alarm

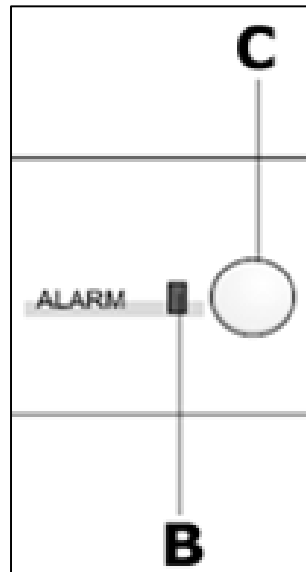

Your appliance is equipped with temperature sensors in the fridge and freezer sections.

- The sensors assess the temperatures being achieved by the fridge and freezer sections.
- If the recorded temperature in either section goes above the temperature that you have set on the thermostat dial, the warning alarm neon (red) will light.
- There will also be an audible warning signal, to make you aware that the sensors have sensed a temperature rise.
- The warning alarm neon will stay switched on until the recorded temperature has fallen to the level set on the thermostat dial.
- To silence the audible alarm, press the warning alarm off button.
- Please note, the warning alarm neon will switch on if either of the doors have been open for a period of time. Or if the thermostat dial has been turned clockwise to a colder setting.
- If the warning alarm neon (red) stays lit for a prolonged period, then you should contact the Baumatic Customer Care Department.

Saving energy when using your fridge-freezer

There are some simple things you can do to save energy when installing or using your fridge-freezer:

Installing:

- Install the appliance in a cool position. If it is placed in direct sunlight or next to an oven or other heat source, the energy consumption can increase substantially.
- Ensure the appliance is installed with the correct ventilation requirements. Restricting ventilation can increase the energy consumption by 15%.

Cleaning and Maintenance:

- Occasionally clean the condenser coils (if present) at the back of the appliance to maintain a high performance level.
- Clean the door gasket with warm water or a neutral detergent that leaves no residue. A tight-sealing door gasket is critical to the efficiency of your appliance.

Usage:

- Do not open the door repeatedly or more frequently than you have to.
- Do not set the thermostat too low. A change of just one degree can effect the energy consumption by 5%. Use a thermometer to check the temperature.
- The freezer compartment should operate at -15 to -18 degrees Celsius. The refrigerator compartment should operate at around 3 to 4 degrees Celsius.
- Allow food to sufficiently cool before putting it in the appliance (but do not let it sit at room temperature for too long).
- In the freezer compartment, food packages should be scattered and never grouped or stacked together until they are completely frozen.
- If you are going away for a long period of time, turn off the appliance, empty and clean it and leave the door ajar.

- If you have a second appliance that is not used, make sure that it is stored with the power off and the door left ajar until it is actually required.

Disposing:

- If you're going to throw out your old fridge, see if there's a chlorofluorocarbons (CFCs) recycler in your area. The government department which looks after the environment in your area may be able to help you.

Cleaning and maintenance

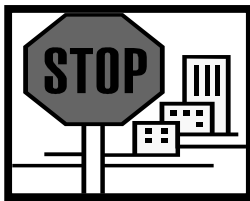

WARNING: PLEASE ENSURE THAT YOUR APPLIANCE IS DISCONNECTED FROM YOUR MAINS SUPPLY BEFORE ATTEMPTING TO CLEAN IT.

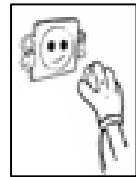

- Do not clean the appliance by pouring water onto it or spraying water over it.

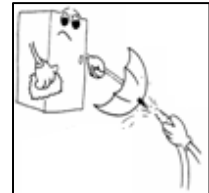

- The refrigerator and freezer compartment should be cleaned periodically, using a solution of bicarbonate of soda and lukewarm water.

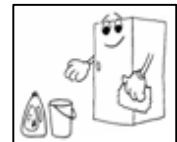

- Clean the accessories separately with soap and water. Do not clean them in a dishwasher.

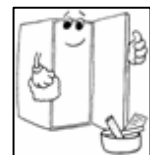

- Do not use abrasive products, detergents or soaps.



- After washing the appliance, wipe over the area that you have cleaned with a damp cloth and then dry it thoroughly.

- When cleaning is complete, dry your hands and then reconnect the plug to your mains supply.

The defrost drain hole

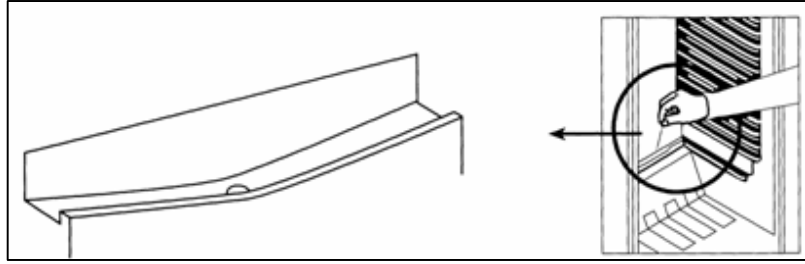

- Defrosting occurs automatically in the refrigerator compartment during operation. The defrost water is collected by the evaporating tray and evaporates automatically.
- The drain hole should be cleaned periodically with the drain hole cleaner. This will prevent water from collecting in the bottom of the refrigerator, instead of flowing down the defrost drainage channel and drain hole.
- **IMPORTANT:** Please note that the drain hole cleaner should not be left in position permanently. Otherwise this may prevent the defrost water from entering the drain hole.
- You can also pour a small amount of water down the drain hole to clean the defrost drainage channel.
- You should be careful to make sure that food packages do not touch the rear wall of the appliance, as this can interrupt the automatic defrosting process and deflect water into the base of your refrigerator.
- Use a solution of bicarbonate of soda and lukewarm water to clean the evaporating tray.
- **IMPORTANT:** It is normal to get some ice droplets forming on the back wall of the appliance. The formation of ice droplets does not indicate an appliance fault.

Defrosting the freezer compartment

Your appliance is frost free, so you will not need to manually defrost the freezer section.

However if for example the door is left open for a prolonged period of time or the door gasket is not sealing correctly, then you could get ice building in the freezer section. If this occurs, then you should follow the steps below and perform a manual defrost.

- The day before you defrost, you should turn the thermostat dial to its maximum setting. This will make sure that the food contained in the freezer section is frozen properly.
- Whilst defrosting the appliance, the food should be removed from the compartment and wrapped in several layers of paper and stored in a cool place. The foods rise in temperature will shorten its storage life and therefore the food should be used within a relatively short period of time.
- **DO NOT PLACE FOOD BACK IN THE FREEZER COMPARTMENT THAT HAS STARTED TO THAW.**
- After ensuring that your hands are dry, disconnect your fridge freezer from your mains supply
- Remove the drawers from the freezer section and leave the door to the freezer compartment open. You can place a bowl of warm water inside of the freezer compartment to speed up the defrost process.
- You can use a sponge to mop up the defrost water that will run into the bottom of the freezer section.
- **IMPORTANT:** *You should place some old towels on the flooring that is immediately in front of the appliance; in case any defrost water comes out of the freezer section and onto the floor.*
- Once all the ice that has built up has melted, then the inside of the freezer compartment should be dried thoroughly. Failure to do this will result in immediate ice build when the appliance is switched back on.
- With dry hands, reconnect your appliance to your mains supply. You should turn the thermostat dial to its maximum setting for 24 hours.
- You should not attempt to freeze fresh food inside the freezer compartment until this 24 hour time period has elapsed.

- Once the 24 hour period has elapsed, you should return the thermostat dial to its normal operating position.
- ***Do not defrost the appliance with other electrical devices (e.g. hair dryer). Do not use sharp metal objects to remove the ice on the freezer, as this could cause damage to the refrigerant system.***

Replacing the light bulb

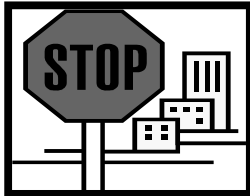

WARNING: PLEASE ENSURE THAT YOUR APPLIANCE IS DISCONNECTED FROM YOUR MAINS SUPPLY BEFORE ATTEMPTING TO REPLACE THE LIGHT BULB.

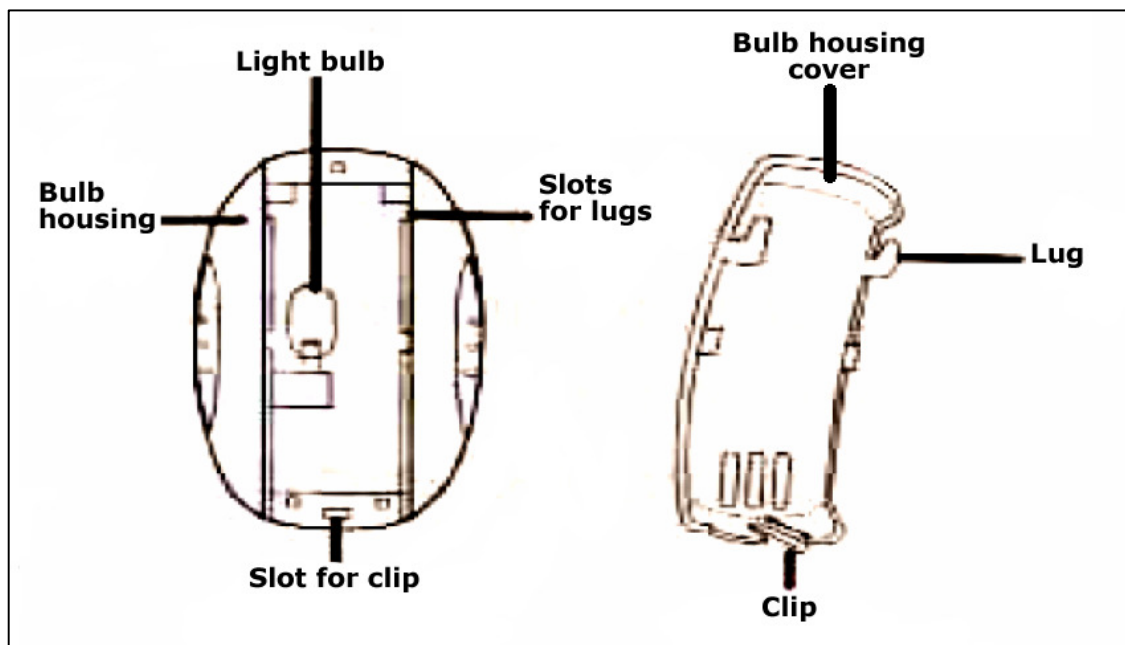
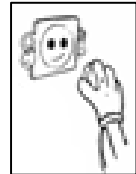

- There is an interior light in the top of the refrigerator section.
- Remove the bulb housing cover, by gently pulling the clip away from its slot. Then slide the cover off, removing the lugs on the cover from the bulb housing.
- Change the present light bulb with a new one. The replacement bulb should not have a greater rating than 15 W.
- Replace the light cover and after waiting five minutes, reconnect your plug to your mains supply.

Installation

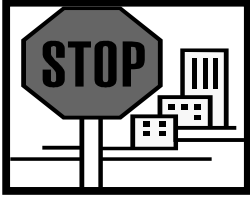

IMPORTANT: Before installation and usage read all the instructions and make sure that the voltage (V) and the frequency (Hz) indicated on the rating plate are exactly the same as the voltage and frequency in your home. The rating plate can be found on the front left edge of the inside of the refrigerator.

The manufacturer declines all responsibility in the event of the installer failing to observe all the accident prevention regulations in force, which are necessary for normal use and the regular operation of the electric system.

Electrical connection



YOUR FRIDGE FREEZER IS INTENDED FOR FITTED AND PERMANENT INSTALLATION.

We recommend that the appliance is connected by a qualified electrician, who is a member of the N.I.C.E.I.C. and who will comply with the I.E.E. and local regulations.

- Your refrigerator comes supplied with a 13 amp plug fitted. If in future you need to change the fuse in this plug, then a 13 amp ASTA approved (BS 1362) fuse **must** be used.
- The wiring in the mains lead is coloured as follows:

Brown	Live
Blue	Neutral
Green and yellow	Earth
- As the colours of the wires in the appliance's mains lead may not correspond with the coloured markings identifying the terminals in your spur box, please proceed as follows:

The **brown wire** must be connected to the terminal marked "L" (live), or coloured **red**.

The **blue wire** must be connected to the terminal marked "N" (neutral), or coloured **black**.

The **green and yellow wire** must be connected to the terminal marked "E" (earth), or by the earth symbol, or coloured **green and yellow**.

- When the connection is completed, no stray strands or cut wire should be present. The cord clamp must be secured over the outer sheath.

Positioning

- It is advisable that your appliance is only installed in a location where the ambient temperature of the room, corresponds with the climate classification that is stated on the rating plate of your appliance. Your appliance may not function correctly if the ambient temperature falls outside of the following ranges.

<i>Climate classification</i>	<i>Appropriate ambient temperature</i>
SN	+10 to +32 degrees centigrade
N	+16 to +32 degrees centigrade

- Your appliance should not be located in direct sunlight or exposed to continuous heat or extremes of temperature (e.g. next to a radiator or boiler).
- The door should be able to open completely and freely.
- The appliance should be situated so you can easily access the food that is stored in it.
- You should check whether there is an electrical socket available, which will be accessible after your appliance is installed.

Reversing the doors of your appliance

The doors of your fridge freezer can be set to open from the left or the right. If you want the doors to be hinged on the left hand side and opening from the right hand side, you will need to follow the door reversal process.

IMPORTANT: If required, the doors should be reversed **PRIOR** to installing the appliance into the housing unit.

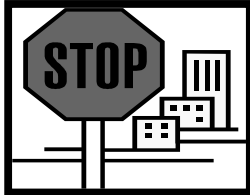

Caution! After unscrewing any of the fixing hinges, hold the door to prevent it from falling and causing damage.



Any parts that you remove from the appliance whilst reversing the door, should be retained for later use.

Tools required

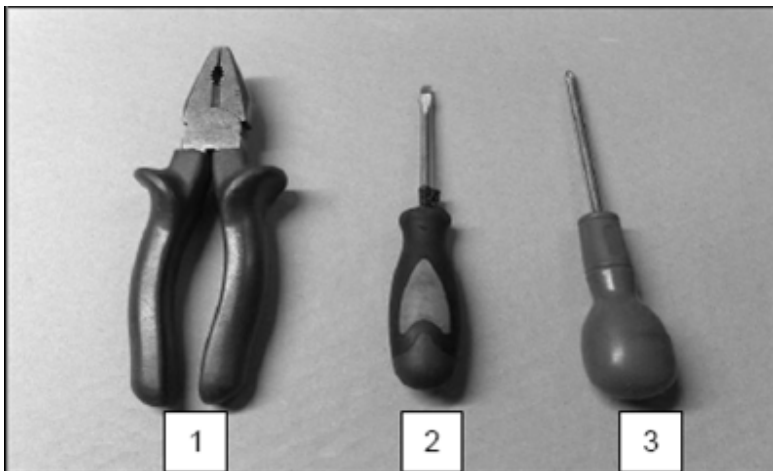

- 1)** Grip pliers
- 2)** Bladed screwdriver
- 3)** Philips star headed screwdriver



- a)** Remove the upper support plate by removing the screws from the top and then sliding the support plate forward.

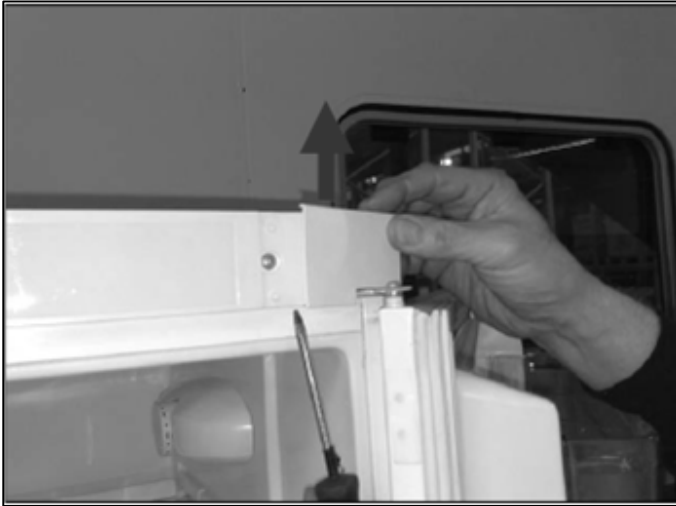

b) Remove the hinge cover by lifting it off from the position shown in the photo opposite.



c) Unscrew the two screws and then remove the top hinge.



d) Remove the refrigerator door by lifting it upwards and away from the middle hinge.

- Place it on a cushioned surface, so that damage does not occur to it.



e) Unscrew the two screws and remove the central hinge.



f) Remove the freezer door by lifting it upwards and away from the lower hinge.



g) Unscrew the two screws and remove the lower hinge.



h) Refit the lower hinge on the opposite side.

- **IMPORTANT:** The position of the hinge pin must be changed from the right hole to the left hole (correct position shown in the photograph opposite).



i) Remove the screw cap by using the bladed screwdriver.



j) Remove the screw hole covers.

- **IMPORTANT:** The screw cap and screw hole covers should be retained for use on the opposite side of the appliance.

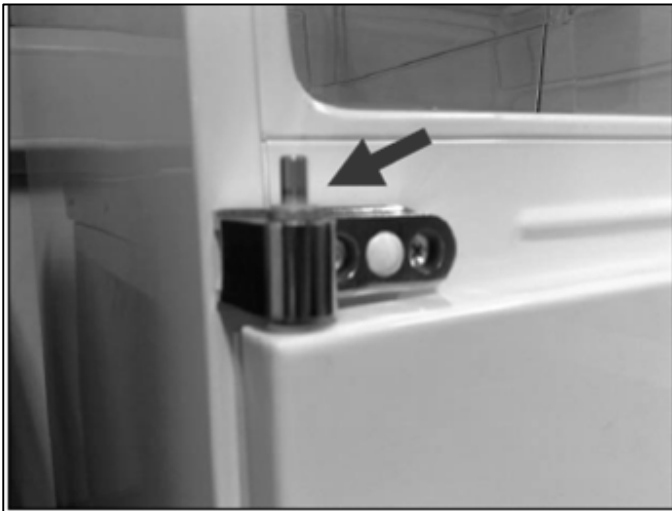

k) Refit the freezer door.

- Reinstall the middle door hinge on the opposite side from its original position.
- **IMPORTANT:** *The hinge pin should be fixed in the position shown in the photograph opposite.*



l) Refit the refrigerator door and install the new door hinge bracket (part of the fixing kit).

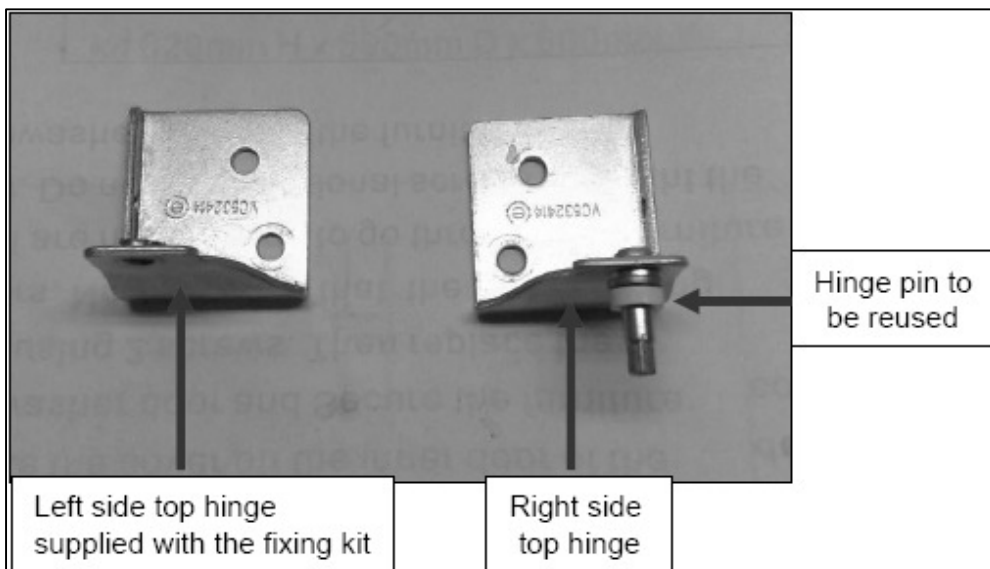

- The above photograph shows the new left side top hinge that is part of the fixing kit.
- The hinge pin from the original hinge bracket should be utilised.



m) Refit the upper support bracket.

IMPORTANT: Check that both the upper and lower doors open and shut correctly, without fouling, after you have completed the door reversal process.



After the door has been reversed, you should check the door seal of the fridge and freezer door. Neither seal should be creased or crushed; otherwise there will be a gap between it and the inside of the door.

- The seal must adhere properly all the way around the door.

- If either seal is not adhering to the cabinet properly, then you should either:-
 1. Use a warm damp cloth and manipulate the seal until it does adhere to the cabinet properly, all the way around the door.or
 2. Use a hair dryer on its lowest heat setting and lightly heat the areas of the door seal that are not adhering correctly. The heat will make the seal more pliable and this will allow you to manipulate the seal into the correct position.

IMPORTANT: DO NOT HEAT THE DOOR SEAL ON ANYTHING BUT THE LOWEST HEAT SETTING, OR HEAT THE SEAL FOR A LONG PERIOD OF TIME. OTHERWISE DAMAGE MAY BE CAUSED TO THE DOOR SEAL, WHICH WOULD NOT BE RECTIFIED UNDER THE GUARANTEE FREE OF CHARGE.

IMPORTANT: WHEN YOU HAVE REVERSED THE DOORS OF THE APPLIANCE. AS YOU HAVE PLACED THE APPLIANCE ON ITS SIDE, YOU MUST WAIT FOR 8 HOURS BEFORE SWITCHING THE APPLIANCE BACK ON.

Aperture dimensions and ventilation requirements



1) The appliance aperture should be:

Height-	1780 mm
Depth-	550 mm
Width-	570 mm



2) The height of the aperture needs to be exactly 1780 mm.

- If necessary, you should utilise extra filler shelves to fill any additional space that you have in the aperture.

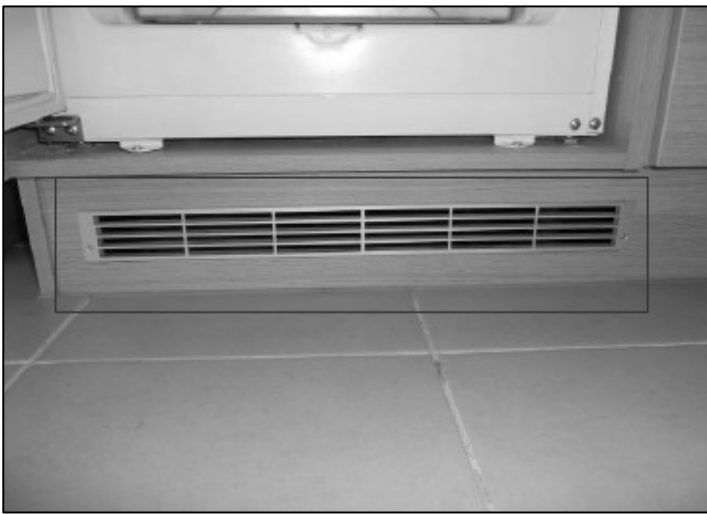

3) IMPORTANT: The appliance aperture **MUST** have a minimum of 200 cm² free air flow for ventilation.

- The appliance requires ventilation and it will not function properly without ventilation.

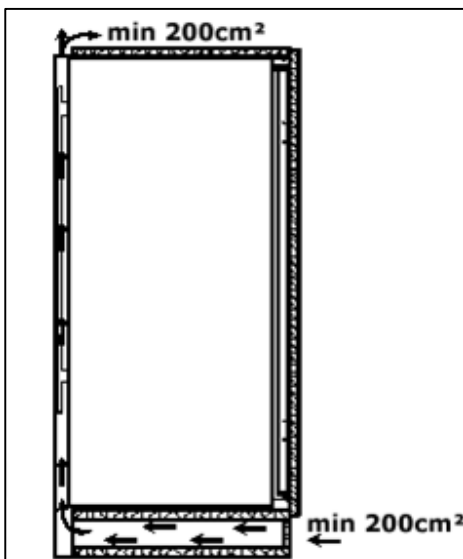

The minimum amount of ventilation that is required is shown in the above diagram.

Installing your fridge freezer



- a) Install the appliance towards the left hand side of the housing unit, leaving a gap of approximately 5 mm.



- b) Fix the appliance to the top shelf of the housing unit.
- o **IMPORTANT:** This will help to keep the appliance vertically parallel with the décor doors.

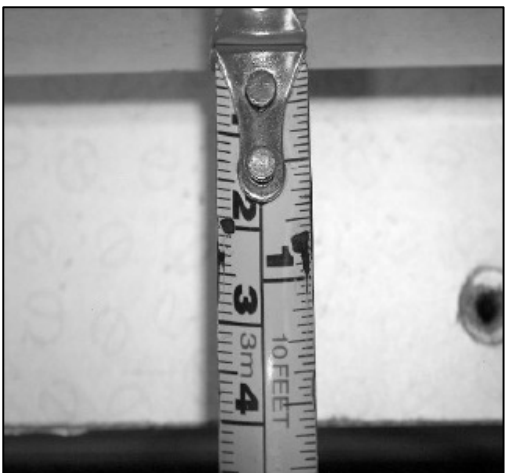

- c) Measure a distance of approximately 40 mm between the front edge of the housing unit and the front edge of the appliance.



d) Fix the appliance into position.



e) Trim the side gasket to an appropriate size and then insert it into the 5 mm gap that you left in step 4.



f) Remove the screw caps and the screw.



g) Fix the bracket that is supplied with the fixing kit into position.



h) Fix the flat bracket that is supplied with the fixing kit, on the opposite side of the appliance. It should be inserted behind the central hinge.



i) The flat bracket can be inserted behind the central hinge without taking the hinge apart.

- This can be done by loosening the middle screw, which can be found behind the screw cap.
- Once the flat bracket has been inserted behind the central hinge, the middle screw must be fully retightened.



j) Install the slider guides on the edge of the appliance doors (there are 2 slider guides per door).

- Insert the sliders into the slider guides.
- Mark the distance from the front edge of the furniture door, to the edge of the slider. This measurement should be approximately 20 mm.

- Fix the sliders into position; the screws must be fully tightened.



k) Check that both furniture doors open and close properly, without fouling on the kitchen cabinet.

- You should also ensure that the doors of the appliance and the door seals are shutting properly against the cabinet of the fridge freezer.
- Installation completed.

Troubleshooting



IMPORTANT: If your fridge freezer appears not to be operating properly, before contacting the Baumatic Customer Care Department, please refer to the checklist below.



My fridge freezer does not appear to be working/there is no power to my appliance.

- Check that the plug is fully inserted into the power socket.
- Check that there is power to your mains supply (e.g. that there hasn't been a power cut or that the fuse hasn't blown).
- Check that the thermostat has not been turned to the off position.
- Check that your mains supply voltage, corresponds to the voltage stated on the rating plate of your appliance.



My fridge freezer appears to be performing poorly

- Check that the appliance isn't overloaded and that food hasn't been packed too tightly into it.
- The thermostat setting is too low; you should turn the thermostat up higher.
- Ensure that the door is closing properly and that the door has not been opened for a prolonged period in error.
- Ensure that there is adequate ventilation for your appliance.



My fridge freezer is noisy

- The refrigerant gas that circulates the pipe work of the appliance may make a slight noise, even if the compressor is not running.
- If the noise worsens or the appliance gets louder than normal; check that it is levelled off correctly, that nothing is touching the rear of the fridge freezer and that nothing placed inside the appliance is rattling.



Ice has formed on the inner back wall of my fridge

- Check that food has not been pushed too far back inside the appliance, so that it is in contact with the inner back wall.
- ***IMPORTANT:*** *It is normal to get some ice droplets forming on the back wall of the appliance. The formation of ice droplets does not indicate an appliance fault.*



There is water in the base of the fridge or leaking out of my fridge.

- Follow the "The defrost drain hole" section on page 18.



IMPORTANT: If your appliance appears not to be operating correctly, then you should disconnect it from your mains supply and then contact the Baumatic Customer Care Department on telephone number (0118) 933 6911.

DO NOT ATTEMPT TO REPAIR THE APPLIANCE YOURSELF.

Please note that if an engineer is asked to attend whilst the product is under guarantee and finds that the problem is not the result of an appliance fault, then you may be liable for the cost of the call out charge.

The appliance must be accessible for the engineer to perform any necessary repair. If your appliance is installed in such a way that an engineer is concerned that damage will be caused to the appliance or your kitchen, then he will not complete a repair.

This includes situations where appliances have been tiled in, sealed in with sealant, have wooden obstructions placed in front of the appliance, like plinths. Or any installation other than the one specified by Baumatic Ltd. has been completed.

Please refer to the conditions of guarantee that appear on the warranty card that you receive with the appliance when it is delivered.

Baumatic Consumables

- **BC001** Degreaser for Dishwashers (200 g)
- **BC002** Descaler for Washing Machines and Dishwashers (200 g)
- **BC003** Ceramic Hob Cleaner (250 ml)
- **BC004** Oven Cleaner (250 ml)
- **BC005** Stainless Steel Cleaner and Protector (250 ml)
- **BC007** E-Cloth – General Purpose Cloth
- **BC008** Microwave Cover

To order a Baumatic consumable product please call 0123 5437 244 and quote the product code. You can also order online from eshop.baumatic.co.uk

Technical Data

Manufacturer	BAUMATIC LTD
Model Number	BRB2617
Product Category	7 – Refrigerator-Freezer
Energy Efficiency Class (1)	A
Annual Energy Consumption (2)	334 kWh
Storage Volume of Fridge Compartment	158 litres
Storage Volume of Freezer Compartment	91 litres
Star Rating	4
Frost Free Compartments	Fridge and Freezer
Temperature Rise Time	5 hours
Freezing Capacity	4kg/24hr
Climate Class (3)	N
Noise Level	45 dB
Installation Type	Built-in

(1) On a scale from A+++ (highest efficiency) to G (lowest efficiency).

(2) Annual energy consumption based on standard test results for 24 hours. The actual energy consumption will depend on how the appliance is used and where it is located.

(3) This appliance is intended to be used at an ambient temperature between "16°C" (lowest temperature) and "32°C" (highest temperature).



United Kingdom

Baumatic Ltd.,
Baumatic Buildings,
6 Bennet Road,
Reading, Berkshire
RG2 0QX
United Kingdom

Sales Telephone

(0118) 933 6900

Sales Fax

(0118) 931 0035

Customer Care Telephone

(0118) 933 6911

Customer Care Fax

(0118) 986 9124

Spares Telephone

(01235) 437244

Advice Line Telephone

(0118) 933 6933

E-mail:

sales@baumatic.co.uk
customercare@baumatic.co.uk
spares@baumatic.co.uk
technical@baumatic.co.uk

Website:

www.baumatic.co.uk

Facebook:

www.facebook.com/baumatic.uk

Republic of Ireland

Service Telephone

1-890 812 724

Spares Telephone

091 756 771

Czech Republic

Baumatic CR spol s.r.o.
Lípová 665
460 01 Liberec 4
Czech Republic

+420 483 577 200

www.baumatic.cz

Slovakia

Baumatic Slovakia, s.r.o.
Galvániho 7/D
Slovakia

+421 255 640 618

Germany

Baumatic GmbH
Bachstr.10-12
D-32257 Bünde
Deutschland

+49 (0) 5223 99408 0

www.baumatic.de

Italy

Baumatic Italia S.R.L.
Via Galvani N.3
35011 Campodarsego (PD)

+3904 9920 2297

www.baumatic.it

Holland

Baumatic Benelux B.V.
Dukdalfweg 15d
1332 BH ALMERE
Nederland

+3136 549 1555

www.baumatic.nl

