

**BWMI 1206 /  
BWMI 1407  
Fully integrated  
washing machine**

**INSTRUCTION MANUAL**

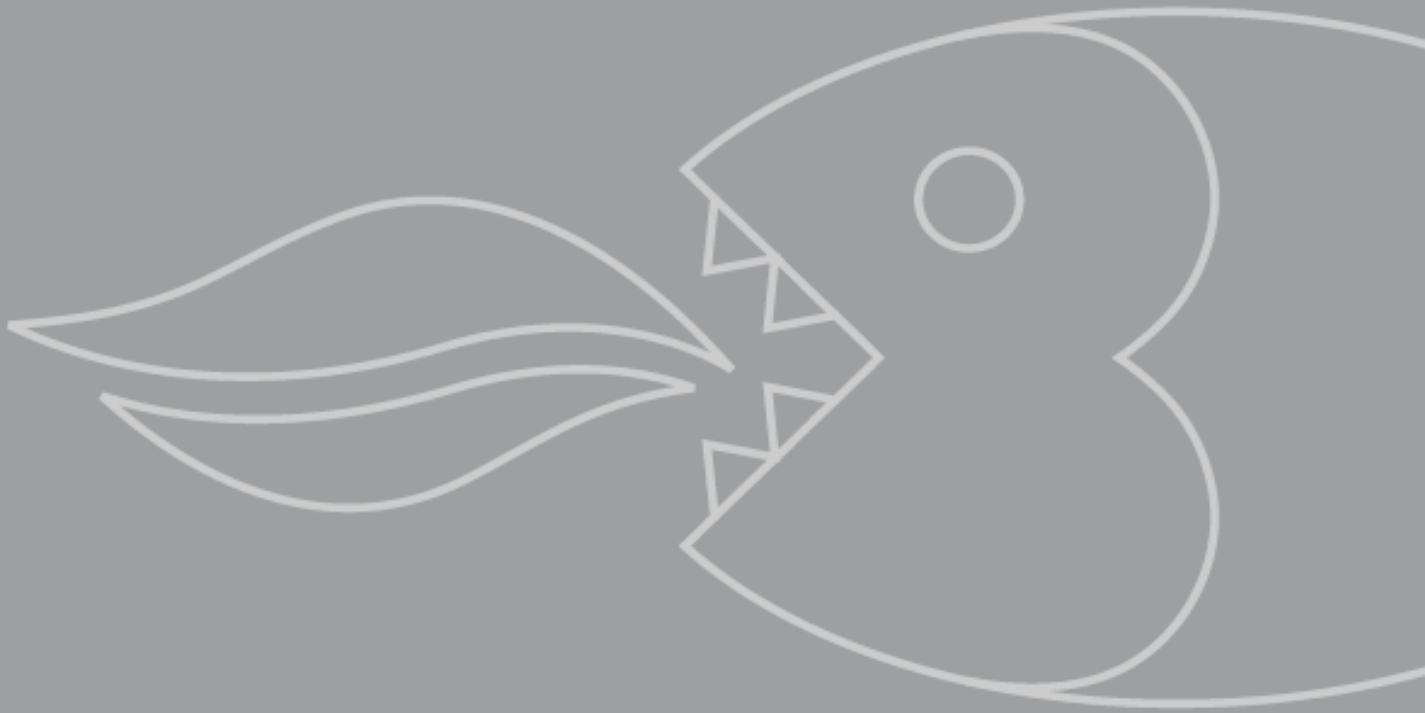

# USER MANUAL FOR YOUR BAUMATIC

## BWMI 1206

## BWMI 1407

# Fully integrated washing machine



***NOTE: This User Instruction Manual contains important information, including safety & installation points, which will enable you to get the most out of your appliance. Please keep it in a safe place so that it is easily available for future reference.***

GS 08/03/11

# Contents

<b>Environmental note</b>	4
<b>Important safety information</b>	5 - 6
<b>Specifications</b>	7 – 8
Product and aperture dimensions	7
Product specifications	7 – 8
Baumatic consumables	8
<b>Control panel</b>	9 - 13
Detergent drawer	12 - 13
<b>Preparing the wash cycle</b>	13 - 19
Preparing your garments for washing	13 - 14
A selection of wash care symbols	14
Detergents and conditioners	15
Program table	16 - 17
Program description	17 – 19
Wash program guidance	19
<b>Selecting a wash program</b>	19 - 23
Cancelling or pausing a wash program	20
Delay start feature	20 – 21
Saving energy when using your washing machine	21
Automatic consumption reduction	21
Removing stains	22
Stain removal rules	22
Stain removal guide	22 - 23
<b>Maintenance and cleaning</b>	24 - 26
In daily use	24
Control panel and washing machine cabinet	24
Detergent drawer	24 - 25
The washing machine drum	25
Door	25
90 degree maintenance wash	25
Long periods of not in use	26
<b>General troubleshooting</b>	26 - 27
Poor wash results	28
<b>Installation</b>	29 - 36
Unpacking and removing the transit bolts	29 - 30
Positioning and levelling the appliance	30 – 31
Fitting the décor door	31 - 33
Connecting to the mains water supply	33
Water outlet	34
Power supply	35
Before first use maintenance wash	35 – 36
<b>Contact details</b>	37

## Environmental note

***Note: Before discarding an old appliance, switch off and disconnect it from the power supply. Cut off and render any plug useless. Cut the cable off directly behind the appliance to prevent misuse. This should be undertaken by a competent person. Disable the door lock to make sure that children cannot get stuck inside the appliance.***

**This appliance is marked according to the European directive 2002/96/EC on Waste electrical and Electronic Equipment (WEEE). By ensuring this product is disposed of correctly, you will help prevent potential negative consequences for the environment and human health, which could otherwise be caused by inappropriate waste handling of this product.**

The symbol  on the product, or on the documents accompanying the product, indicates that this appliance may not be treated as household waste. Instead it shall be handed over to the applicable collection point for the recycling of electrical and electronic equipment.

**Disposal must be carried out in accordance with local environmental regulations for waste disposal.**

**For more detailed information about treatment, recovery and recycling of this product, please contact your local city office, your household waste disposal service or the shop where you purchased the product.**



## Important safety information



Your safety is of the utmost importance to Baumatic. Please make sure that you read this instruction booklet **before** attempting to install or use the appliance. If you are unsure of any of the information contained in this booklet, please contact the Baumatic Advice Line.

### General Safety

- Repairs to your appliance must only be carried out by a Baumatic engineer or one of its authorised service agents. Any attempt by an inexperienced person to repair the appliance, could result in injury or damage to your washing machine.
- If you notice that the mains cable is damaged. **The appliance must not be used.** The same applies if you notice that the worktop, control panel or base area is damaged. As this could allow access to the internal components of the machine.
- The appliance should be switched off and isolated from the mains supply, before either cleaning or maintenance work is attempted.
- The mains cable must not be used to pull the plug out of the electrical socket.
- The machine should not be sprayed with water.
- The glass of the porthole door may become hot during the higher temperature wash programs.
- The machine should be allowed to cool before carrying out an emergency drain or cleaning the drain filter.
- It is possible for small animals to chew either mains cables or water hoses, which could cause an electric shock hazard.

### Installation

- The installation instructions contained within this user manual should be followed.
- It is obligatory for the completed installation to comply with all relevant building regulations and local water authority requirements.

- ***Before the first use of the appliance, we advise that a 90°C cotton wash is completed. No garments should be placed inside the machine; however a small amount of detergent must be used.***

## **During Use**

- It is recommended that the appliance is unplugged and the water supply is switched off after the machine is used.
- This appliance is only designed to wash normal domestic washloads. If you use your washing machine in any other way or it is incorrectly used, then Baumatic accepts no liability for any damage that might be caused and any guarantee will be void.
- No attempt should be made to alter or modify the specifications of this appliance.
- The detergents that you place in this appliance should be suitable for automatic washing machines. With regards to dosage levels, the detergent manufacturer's recommendations should be followed.
- You should not wash garments that have been in contact with flammable materials.
- Your washing machine should not be used for dry cleaning.
- If you use either dyes or bleaching agents inside this machine, then you should consult with the manufacturer of these products to make sure they are suitable for use in your washing machine. Baumatic cannot be held responsible for any damage that may result.

## **Child Safety**

- Your washing machine should only be used by adults. You should not allow children in the area of the machine unsupervised. You should not let them touch the controls or play with the appliance.
- It could be possible for a child or pet to gain access to the washing machine through the porthole door. Therefore please check the drum before using the appliance.
- Any packaging that is removed from the machine should be kept away from children.
- All detergents should be kept out of children's reach in a safe place.

## Specifications

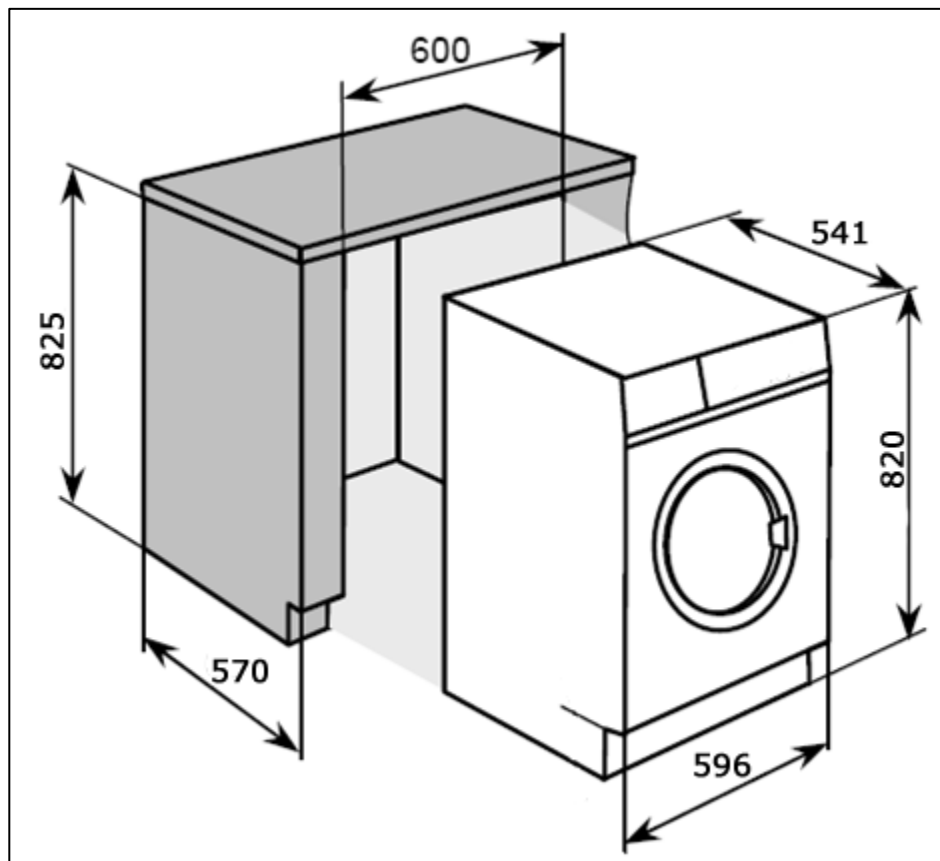

### Product dimensions:

Height: 820 mm  
Width: 596 mm  
Depth: 541 mm

### Aperture dimensions:

825 mm  
600 mm  
570 mm

### Product specifications

#### BWMI 1206

#### BWMI 1407

- Load capacity: 6 kg
- Maximum spin speed: 1200 rpm
- Drum size: 46 litres
- **15 wash programs**
- 3 option buttons: Stain Remover, Extra Rinse and Anti-Crease
- Variable spin speed with no spin option
- Porthole diameter: 30 mm
- 180° door opening
- LED display
- Digital countdown indicator
- Delay start
- Separate temperature control option

- Automatic consumption reduction
- Self-adjusting water level to load
- Imbalance control system
- Overflow protection
- Foam protection
- Safety lock
- Fuzzy logic
- Adjustable feet

**Energy efficiency:**

Energy rating	A+
Wash performance	A
Water extraction performance class	B ( <b>BWMI 1206</b> )
	A ( <b>BWMI 1407</b> )

**Baumatic Consumables**

- **BC002** Washing Machine and Dishwasher Descaler (200g)
- **BC006** Washing Bag (40 x 60 cm)

To order a Baumatic consumable product please call 0123 5437 244 and quote the product code. You can also order online from [eshop.baumatic.co.uk](http://eshop.baumatic.co.uk)



## Control panel

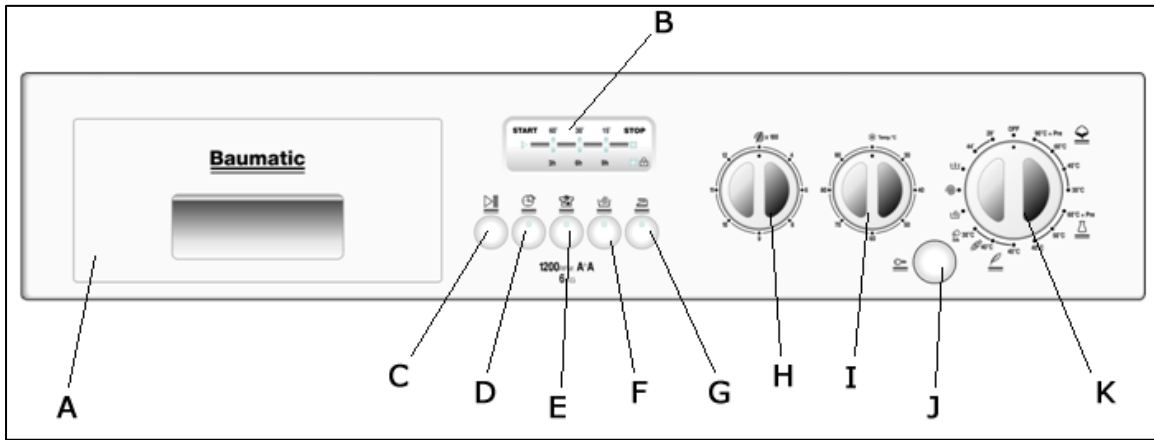

- A) Detergent drawer
- B) Cycle progress indicator
- C) Start / pause button
- D) Delay start button
- E) Stain remover button
- F) Extra rinse button
- G) Anti-crease button
- H) Spin speed control knob
- I) Wash temperature control knob
- J) Door open button
- K) Program selection knob

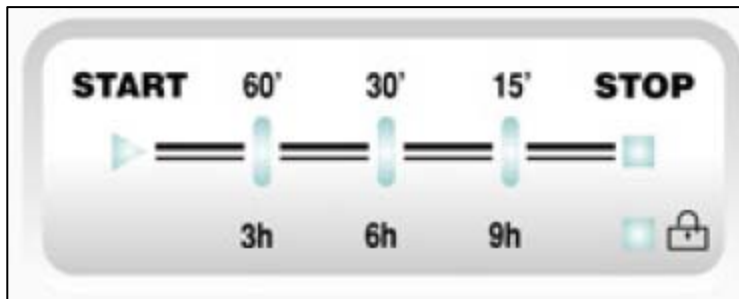

### Cycle progress indicator

This display shows the time remaining for a set wash program. The icons indicate the following remaining times:

- Start light: Remaining time above 60 minutes
- 60 light: Remaining time less than 60 minutes
- 30 light: Remaining time less than 30 minutes
- 15 light: Remaining time less than 15 minutes
- Stop light: End of the program.

The display also shows the set delayed start time of 3, 6 or 9 hours. The stop light will flash while a program is being set until the program has started or the program selection knob is returned to the "OFF" position.



### Start / pause button

This button should be used to start the chosen wash program. When the button is pressed, the appliance will begin the cycle within a few seconds. You can also press this button to pause a wash cycle in progress and continue after. **When a program is selected, wait for the STOP light to flash before pressing the Start / Pause button.**



### Delay start button

This button can be used to program a delay start of 3, 6 or 9 hours. See the section "Delay start feature" for instructions.



### Stain remover button

This option is useful for heavily soiled loads and can be used only on some programs.



### Extra rinse button

This button will program the machine to add an additional rinse to the cycle. This function is ideal for people with sensitive skin as it removes more of the detergent from washing. It is advisable to use this function for very dirty loads where extra detergent has been used. This option can be used only on some programs.



### Anti-crease button

Use this button to select the anti-crease function. This will minimise creases in mixed fabrics, delicate fabrics and woollens and silk. It works in the following ways:

<b><i>Fabric (according to program selected)</i></b>	<b><i>Process</i></b>
Mixed fabrics	The water is gradually cooled throughout the final 2 rinses with no spinning and then a delicate spin assures the maximum relaxation of the fabrics.
Delicate fabrics	The final 2 rinses are carried out with no spinning and then the fabrics are left in water until it is time to unload. When you are ready to unload, press the anti-crease button <b>(G)</b> to drain.
Woollens / silk	After the final rinse the fabrics are left in water until it is time to unload. When you are ready to unload, press the anti-crease button <b>(G)</b> to drain and spin.

## Spin speed control knob

**BWMI 1206**

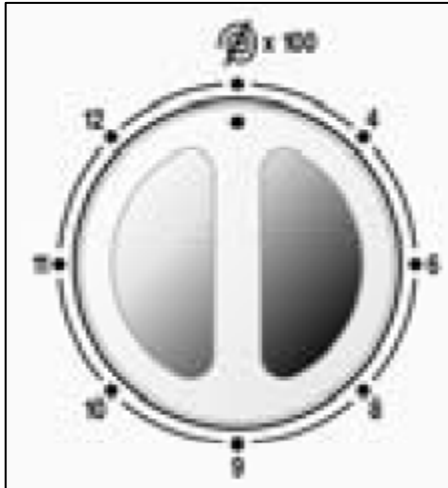

**BWMI 1407**

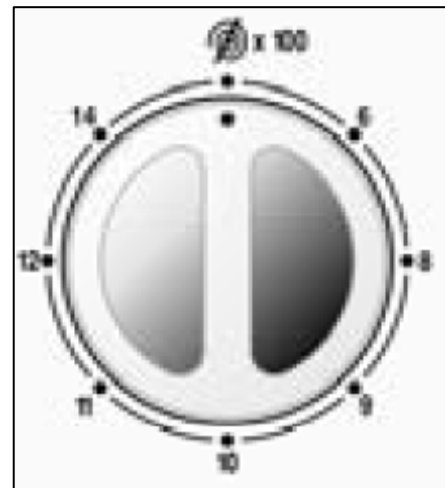

The spin cycle is important to remove as much water as possible from the laundry without damaging the fabrics. You can adjust the spin speed of the machine to reduce the maximum speed. The machine is fitted with an imbalance control system to cancel the spin cycle if the load is unbalanced. This reduces the noise and vibration in the machine.



You can rotate the dial to this symbol to select "No Spin".

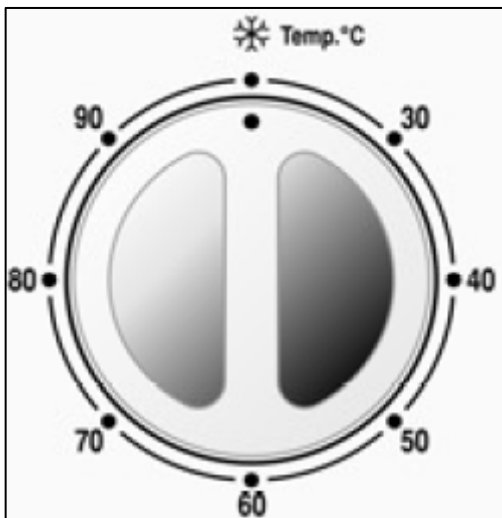

## Wash temperature control knob

*This control knob enables you to reduce, but not increase, the washing cycle temperature. Please refer to the program table for information on the maximum temperature advised for each wash cycle.*



## Door open button



A safety device prevents the door from being opened immediately after the end of the cycle. You should wait for 2 minutes after the program has finished and ensure the door

security light on the cycle progress indicator has gone out before opening the door. ***If the door is not closed, the indicator will continue to flash.***

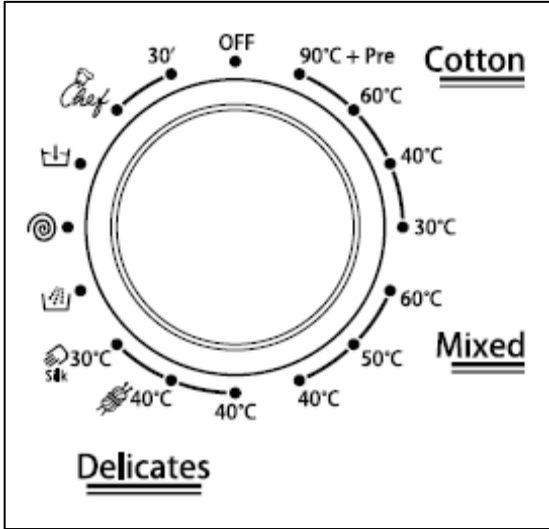

### Wash program selection knob

This control knob allows you to select the wash program of your choice. You can rotate the knob in both directions.

### Detergent drawer

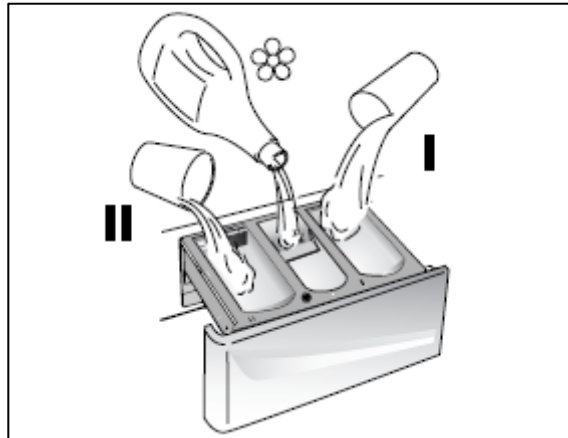

#### Pre wash section

This compartment should have detergent placed in it, if you are going to select a wash program that has a pre wash as part of it.

#### Main wash section

This compartment should have detergent placed in it (you should also put a water softening agent in this section, if you use one). The detergent will be added to the drum at the start of the main wash program.

## Conditioner section



This compartment should be used for liquid conditioners (fabric softener, starch). They will be added to the wash load during the final rinse.

**IMPORTANT: Only liquid products should be used in the conditioner compartment. The machine is programmed to automatically take up additives during the final rinse stage for all wash cycles.**

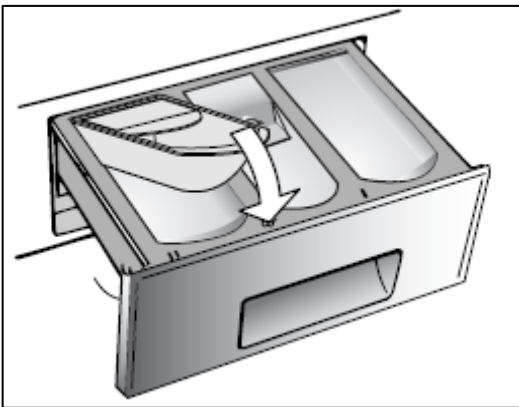

- If liquid detergents are used, insert the special container supplied into the compartment labelled "II".
- This ensures that the liquid detergent enters the drum at the right stage of the wash cycle.

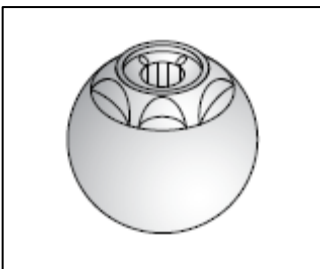

- Some detergents are difficult to utilise so an in drum dispenser should be used if recommended by the detergent manufacturer.

## Preparing the wash cycle

### Preparing your garments for washing

- Your washing should be sorted out, according to the fabric type and the wash care symbol that is printed on the garment's wash care label. (See separate section on wash care symbols).



- Your washing should also be sorted out according to the degree of soiling.

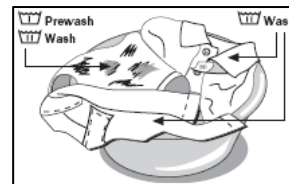

- Check all pockets on a garment to make sure that they are empty.

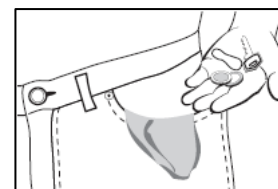

- Remove any detachable metal items (badges, paperclips, safety pins etc).
- Zips should be closed, duvet covers and pillow cases should be buttoned up and any loose straps should be tied up. This will help to prevent other garments from getting damaged during the wash.
- Woollens and knitted coloured fabrics should be turned inside out before being washed in the appliance.
- Small delicate items (tights, baby socks) should be placed in either a washing net or a zipped pillow case.
- Curtains should be handled with particular care. All plastic hooks or metal strips must be removed before being washed in the appliance.
- Coloured items and whites should be washed in separate wash cycles.
- New garments often contain an excess of dye, therefore it is advisable to wash them separately for their first wash.
- Garments should be unfolded and shook out before being placed inside the machine.

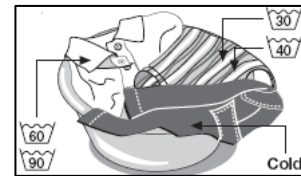

### A selection of wash care symbols

<b>Washing</b>	Boiling temp 95°C	Normal temp 60°C	Normal temp 40°C	Do not wash!	Bleachable in cold water	Do not bleach!	Wool seal
<b>Dry cleaning</b>	Delicate temp 30°C	Delicate temp 40°C	Hand wash only	All solvents	All but TRI	Benzine only	Do not clean!
<b>Spin dryer</b>	Normal	Low	High	Do not dry!	Hang to dry	Drip dry	Dry flat
<b>Ironing</b>	110°C	150°C	200°C	Do not iron!			

- The wash care symbols should be used to help you to select the most suitable wash program. They will also help you to sort your laundry into different loads, depending on the fabric type and the highest temperature which the garment can be washed at.
- If the wash care label does not appear in the above table, then please refer to the washing machine program chart. This gives more detailed descriptions of the types of fabric that are suitable to be washed using a particular wash program.

## Detergents and conditioners

The amount of detergent that you need to use in your appliance, will depend on

- ***The degree of soiling.*** Lightly soiled garments in general require less detergent.
- ***The size of the wash load.*** A smaller wash load will require a reduction in the amount of detergent.
- ***The hardness of your tap water.*** The harder your water is, then the more detergent you will need to use. The detergent manufacturers normally give guidance as to how much extra detergent should be used, depending on the hardness of the water.

### Liquid detergent

If you are using liquid detergent, then in the majority of cases the liquid should be placed inside the dosing device supplied by the detergent manufacturer. All instructions on the detergent packaging should be followed.







### Water softening agents

If your tap water is hard, then it may be prudent to utilise a water softening agent. This will help to ensure that the appliance does not become clogged with hard water deposits. You may also find that it will allow you to lessen the amount of detergent that you are using.





***When using any detergent or water softening agent, the recommendations of the manufacturers should be followed.***

## Program table

Program	Laundry	Control knob position	MAX weight (kg)	Temperature (°C)	Detergent drawer		
							
Resistant fabrics (cotton, linen)	Whites with prewash	90 + Pre	7 <i>BWMI1407</i>	Up to 90	Yes	Yes	Yes
			6 <i>BWMI1206</i>				
Cotton, mixed	Fast coloureds	60	7 <i>BWMI1407</i>	Up to 60	Yes	Yes	No
	Fast coloureds	40	7 <i>BWMI1407</i>				
	Non-fast coloureds	30	7 <i>BWMI1407</i>				
Mixed fabrics and synthetics (mixed, resistant)	Fast coloureds	60	3.5 <i>BWMI1407</i>	Up to 60	Yes	Yes	No
			3 <i>BWMI1206</i>				
Synthetics (nylon, perlon, mixed cotton)	Fast coloureds	50	3.5 <i>BWMI1407</i>	Up to 50	Yes	Yes	No
	Non-fast coloureds	40	3.5 <i>BWMI1407</i>				
Very delicate fabrics	Delicates	40	2	Up to 40	Yes	Yes	No
	Machine washable woollens	 40	1.5	Up to 40	Yes	Yes	No
	Silk, hand-wash	 Silk 30	1	Up to 30	Yes	Yes	No
Specials	Rinse		-	-	No	Yes	No
	Spin		-	-	No	No	No



	Drain		-	-	No	No	No
	"Chef" intense		7 <i>BWMI1407</i>	Up to 40	Yes	Yes	No
	Rapid 30 minute	30'	6 <i>BWMI1206</i> 2	Up to 30	Yes	Yes	No

## Program description

### Cotton

- The cotton program is designed for maximum washing and rinsing efficiency. With spin cycles in between, the program guarantees the laundry is rinsed thoroughly. The final spin cycle ensures laundry is spun dry as much as possible up to the maximum speed.
- The 90+Pre cotton program automatically includes a pre-wash.

### Mixed

- The main wash and rinse gives the best results due to the rotation rhythms of the drum and the water levels.
- A gentle spin ensures the fabrics become less creased.

### Delicates

#### 40°C

- This cycle alternates washing and soaking and is recommended for very delicate fabrics.
- The wash cycle and rinses are carried out with high water levels to ensure best results.

#### 40°C

- This cycle enables you to thoroughly wash woollen garments without damaging them.
- The cycle consists of alternate periods of activity and pauses.



- This program allows a complete washing cycle for garments specified as “Hand-wash only” and laundry items made from silk on the fabric label.
- This cycle has a maximum temperature of 30°C and concludes with 3 final rinses and no final spin.



- This program carries out 3 rinses with an intermediate spin which can be reduced or excluded using the spin speed control knob **(H)**.
- The cycle can be used for rinsing any type of fabric or after hand-washing. This program can also be used as a bleaching cycle.



- The spin program carries out a maximum spin which can be reduced using the spin speed control knob **(H)**.

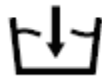

- This program drains out the water.



- This program enables you to wash together different types of fabrics e.g. cotton and synthetic fast coloureds.
- The cycle washes with considerable energy saving by using a temperature of 40°C and alternating spin action with soaking phases.

# 30'

- The 30 minute rapid program allows a complete washing cycle to be carried out in approximately 30 minutes with a temperature of 30°C.
- When using this cycle it is recommended to use only 20% of the recommended quantities shown on the detergent manufacturer's instructions.

## Wash program guidance

- The washing machine automatically selects a spin speed for a particular wash program. However it is possible to reduce the spin speed by using the spin reduction feature.
- **Important:** *You should make sure that the selected spin speed is appropriate for the garments that you are washing.*
- If you use the spin reduction feature, you can make the machine not go into a spin cycle. If you pick this option, then the machine will stop with water in the drum.
- **Important:** *Before opening the door of the appliance, you MUST select the drain program to clear this water.*
- The LCD display shows an approximate time remaining for the selected wash cycle. Please note that factors external to the machine, e.g. the temperature of your water supply, your water pressure etc. can affect the time it takes for the wash cycle to complete.

## Selecting a wash program

- Load your laundry and put detergent in the relevant compartment of the soap drawer.
- Close the porthole door firmly.
- Select the most appropriate wash program for the garments that you are washing, by turning the program selection knob **(K)**.
- Select any program options by using the stain remover button **(E)**, extra rinse button **(F)** or anti-crease button **(G)**.
- Any program option that you select, will affect the length of time that the wash cycle will take to complete.

- Alter the spin speed, if required, using the spin speed control knob **(H)** or change the wash temperature by using the wash temperature control knob **(I)**.
- Press the Start / Pause button **(C)**.
- After approximately 5 seconds, you will hear your washing machine start the wash cycle.
- ***If there is a power failure or the plug is pulled out of the socket when a wash cycle is in progress, once power has been restored, the wash program will continue.***
- Whilst the wash program is in progress, the time remaining to the end of the wash cycle will appear on the display.

### **Cancelling or pausing a wash program**

- To stop a wash program once a wash cycle is in progress, you should press and hold the Start / Pause button **(C)** for about 2 seconds.
- To cancel the program, turn the program selection knob **(K)** to the OFF position.
- If you wish to add or remove items the door will remain locked for two minutes before it is possible to open the door.
- Close the door and press the Start / Pause button **(C)** to continue the wash cycle.



***Before opening the porthole door, you MUST drain the appliance; otherwise there may still be water in the drum when you open the door.***

### **Delay start feature**

Your appliance has a delay start feature, which allows you to pause the start of a wash cycle until a later time. You can delay the start time by 3, 6 or 9 hours.

- Follow the process listed under "Selecting a wash program".
- Before pressing the Start / Pause button **(C)**, you should select the length of time that you want to delay the wash program for by pressing the delay start button **(D)**. The relevant LED will light on the display to show the set delay time.

- Press the Start / Pause button **(C)** to begin the delay countdown. The indicator light for the chosen delay time will stop blinking and remain on.
- At the end of the required delay time, the chosen program will begin.
- To cancel a time delay that has been set, you should press and hold the delay start button **(D)** until the indicator light goes OFF and the stop light blinks.
- You can then start the program manually by pressing the Start / Pause button **(C)** or switch the appliance off by turning the program selection knob **(K)** to the OFF position.

### **Saving energy when using your washing machine**

- To prevent any possible waste of energy, water or detergent, we recommend that you put a full load in your washing machine but without exceeding the recommended maximum load size. Up to 50% of energy saving can be made with one full load compared to two half load washes.
- Only use the pre-wash function with particularly dirty loads. Energy savings of 5% to 15% can be made by not selecting the pre-wash option for normal soiled laundry.
- Using stain removers before machine washing reduces the need to wash at temperatures over 60°C. Energy savings of up to 50% can be made by using a 60°C wash temperature rather than 90°C.

### **Automatic consumption reduction**

- The washing machine is fitted with an automatic consumption reduction system which enables the machine to use the amount of water needed to wash and rinse the laundry in relation to the particular load size.
- This results in a reduction in the amount of water used and electricity needed to heat it to the minimum temperature required without compromising the washing and rinsing performance in any way.
- The amount of water and electricity used will always be appropriate for the amount of laundry which ensures you achieve excellent washing results whilst respecting the environment and saving money.

## Removing stains





*Garments that are covered in stains, grease or are heavily soiled may need to be pre-washed or soaked before being placed inside of the washing machine.*









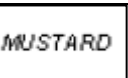

- Soaking helps to remove protein-type stains, like blood, milk or grass.
- Pre-washing helps to loosen soil before the main wash.

## Stain removal rules

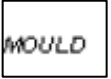
- Use warm water for soaking or pre-washing stained laundry. Hot water can set stains.
- Most stains are easier to remove when they are fresh.
- Before treating any stain try to establish; what kind of stain it is, how old the stain is, what the fabric type is and whether the fabric is colourfast (check the care label to find this out).
- Washing and drying can fix some stains.
- When bleach is recommended, use a mild fabric bleach that is safe for the fabric.
- If you need to use a stain remover, put the stained area face down on a paper towel or white cloth. Apply the stain remover to the back of the stain. This forces the stain off the fabric, instead of through it.

## Stain removal guide

	<b>Stain</b>	<b>Removal Method</b>
	Alcoholic beverages	The stain should be first washed with cold water, then wiped with glycerine and water and rinsed with water mixed with vinegar.
	Shoe polish	The stain should be softly scratched without ruining the material, then rubbed with detergent and rinsed. In case it is not eliminated, rub with 1 unit of pure alcohol (96 degrees) mixed in 2 units of water and then washed with lukewarm water.
	Tea and coffee	Stretch the stained area of material on the top of a container and pour water as hot as the material can endure on it. If the type of material is suitable, wash it with lye.
	Chocolate and cocoa	Leave your clothes in cold water and rub with soap or detergent, wash it in the highest temperature that the material type can endure. If there is still a stain of oil left, wipe with oxygenated water (in proportion of 3%).

	Tomato paste	Scrape the dried pieces without ruining the material, then leave in cold water for about 30 minutes and wash by rubbing with detergent.
	Meat broth/egg	Eliminate the dried stain residues and wipe with a sponge or soft cloth wetted in cold water. Rub with detergent and wash with diluted lye.
	Grease and oil stains	First wipe the residues. Rub the stain with detergent and then wash with lukewarm soapy water.
	Mustard	First apply glycerine to the stained area. Rub with detergent and then wash. If the stain still does not disappear, wipe with alcohol (on synthetic and coloured cloth, a mixture of 1 unit alcohol, 2 units water should be used).
	Blood stain	Lay your clothes in cold water for 30 minutes. If the stain still does not disappear, lay in mixture of water and ammonia (3 table-spoons of ammonia in 4 litres of water) for 30 minutes.
	Cream, ice-cream and milk	Lay your clothes in cold water and rub the stained area with detergent. If the stain has still not disappeared, apply lye on the fabric of your clothes in proper proportion. ( <b>Do not use lye on coloured clothes</b> ).
	Mould	Mould stains should be cleaned as soon as possible. The stain should be washed with detergent, and if it does not disappear, it should be wiped with oxygenated water (in proportion of 3%).
	Ink	Hold the stained area under cold water and wait until the inky water completely runs off. Then rub with water diluted with lemon juice and detergent. Wait five minutes and then wash.
	Fruit	Stretch the stained area of your clothes on the top part of a container and pour cold water on it. Do not pour hot water on the stain. Wipe with cold water and apply glycerine. Wait for 1-2 hours and rinse after wiping with a few drops of white vinegar.
	Grass stain	Rub the stained part with detergent. If the type of fabric is suitable for use of lye, wash it with lye. Rub your woollen clothes with alcohol (for coloured one, a mixture of 1 unit pure alcohol and 2 units of water).
	Oil paint	The stain should be eliminated before it dries by applying thinner on it. Then it should be rubbed with detergent and washed.
	Burnt stain	If your fabric is suitable for the use of lye, you can add lye into your washing water. For woollen fabrics, a cloth dampened in oxygenated water should be pressed on the stain and it should be ironed with a dry cloth on it. It should be washed after rinsing well.

## Maintenance and cleaning

### In daily use

- Once a wash cycle has completed, you should pull out the detergent drawer slightly, so it can dry out.
- Leave the porthole door ajar for a short while after a wash cycle has completed. This should help to prevent stagnant smells and to protect the door seal.
- Close the water tap.
- We suggest that you disconnect the appliance from your mains supply, when it is not in use.

### Control panel and washing machine cabinet.

***IMPORTANT:*** Do not use any abrasive cleaner or household polish on either the control panel or operating parts.

- Wipe over the control panel and the external surface of the machine using a brand new damp cloth with warm water.
- If you ever spill any liquid detergent or conditioner from the detergent drawer onto the washing machine cabinet, then these should be cleaned up immediately as they could be corrosive.

### Detergent drawer

Occasionally the detergent drawer should be cleaned.

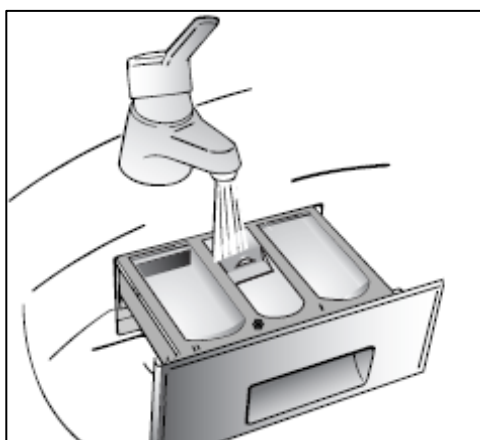

- Pull the detergent drawer out as far as it will go and then remove the drawer by pulling firmly.



- Use warm water and a brush to thoroughly clean the three compartments of the detergent drawer.
- Clean the area that the detergent drawer slides into with a brush.
- Replace the detergent drawer by placing it back into the slot. Then push the drawer fully back into position.

### **The washing machine drum**

The drum of your washing machine is constructed from stainless steel. However if there are objects that can rust placed inside the drum, then it is possible for the drum to become stained.

***IMPORTANT:*** *Do not use a descaling agent, iron/steel wool or scouring agents to clean the drum of your appliance.*

- Remove any rust stains on the drum with an appropriate stainless steel cleaning agent.

### **Door**

- You should regularly check to see if any deposits have formed, or there are any foreign bodies in the rubber door gasket. This sits inside the opening of the porthole door.
- Regularly clean the door glass with a damp cloth. A build up of soiling and residues from the water can result in water leaking from the door.

### **90 degree maintenance wash**

*The warm and damp environment of a washing machine can lead to a bacteria build up inside of the machine and in extreme cases you may even get a "sludge" like material building. To prevent this from happening, you should do the following: -*

- Leave the door ajar for a few minutes after the wash cycle has completed.
- Once a month, set your appliance on a 90 degree wash.
- You should not put clothing inside the appliance for this maintenance wash.
- You should use a wash powder that contains a bleaching agent (i.e. not a wash powder that is only suitable for washing coloured garments).

## Long periods of not in use

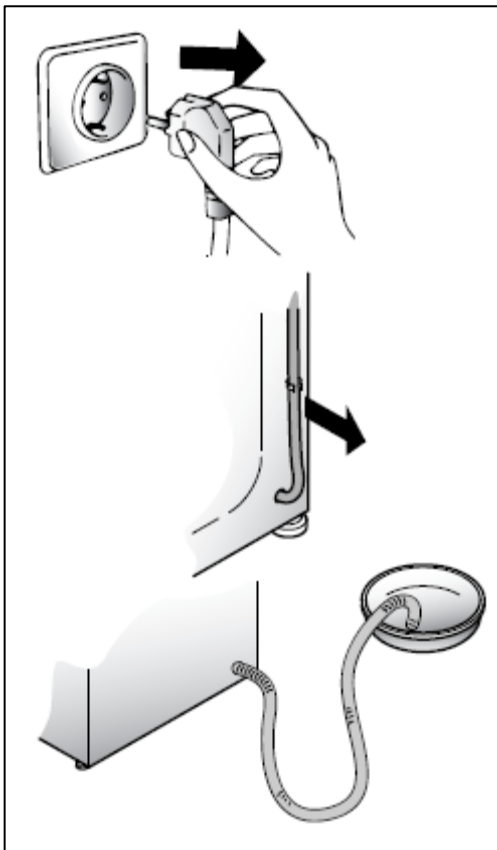

- If the appliance is being transported or is out of use for long periods in unheated places, all remaining water must be completely removed from the hoses.
- Ensure the mains power is off and then unclip the hose and point it downwards into a basin until all the water has emptied out.

## General troubleshooting

If your appliance does not appear to be functioning correctly, please refer to the table below before calling the Customer Care Helpline.

<b><i>Problem</i></b>	<b><i>Cause</i></b>	<b><i>Solution</i></b>
Machine does not work on any program.	<ol style="list-style-type: none"> <li>1) Plug not in the socket</li> <li>2) Not switched on</li> <li>3) Power failure</li> <li>4) Fuse blown</li> <li>5) Door open</li> </ol>	<ol style="list-style-type: none"> <li>1) Plug it in</li> <li>2) Switch it on</li> <li>3) Check</li> <li>4) Check</li> <li>5) Close door</li> </ol>
Does not fill with water.	<ol style="list-style-type: none"> <li>1) As above</li> <li>2) Tap turned off</li> <li>3) Program selection knob not positioned correctly</li> <li>4) Fill hoses are kinked</li> </ol>	<ol style="list-style-type: none"> <li>1) Check</li> <li>2) Turn on the tap</li> <li>3) Position the program selection knob correctly</li> <li>4) Straighten fill hoses</li> </ol>
Water does not drain away.	<ol style="list-style-type: none"> <li>1) Kink in discharge hose</li> <li>2) House drain is blocked</li> </ol>	<ol style="list-style-type: none"> <li>1) Straighten discharge hose</li> <li>2) Clean drain</li> </ol>
Water on floor around the washing machine.	<ol style="list-style-type: none"> <li>1) Leaking gasket between tap and water inlet hose</li> <li>2) House drain is blocked</li> <li>3) Detergent drawer blocked with soap residues</li> </ol>	<ol style="list-style-type: none"> <li>1) Replace gasket and tighten hose and tap well</li> <li>2) Clean drain</li> <li>3) Clean detergent drawer</li> </ol>
Does not spin.	<ol style="list-style-type: none"> <li>1) Water has not yet</li> </ol>	<ol style="list-style-type: none"> <li>1) Wait a few minutes</li> </ol>

	drained away. 2) No Spin option selected	for machine to empty 2) Choose a spin speed using the spin speed control knob <b>(H)</b>
Spinning starts late or the machine does not spin.	1) The imbalance control system has activated because the laundry is unevenly distributed in the drum. 2) If the laundry is still not evenly distributed after 10 minutes, the machine will not spin.	1) The appliance will redistribute the laundry by reversing the drum rotation. This may take several attempts before the laundry is evenly distributed and normal spinning can resume. 2) In the event of this, redistribute the load manually and select the program again.
Machine vibrates a lot during the spin.	1) Washing machine not completely level 2) Transit bolts not removed yet 3) Load not distributed evenly	1) Alter the adjustable feet 2) Remove the transit bolts 3) Rearrange the laundry evenly
Door will not open.	1) 2 minutes have not elapsed since the program finished	1) Wait 2 minutes
The machine makes a different noise when spinning.	This is due to the brush motor which ensures better performance.	N/A
Only a small level of water can be seen in the drum.	Water level automatically set according to the load size so may seem less than usual.	N/A



**IF AN ENGINEER ATTENDS DURING THE GUARANTEE PERIOD AND FINDS THAT A FAULT HAS BEEN CAUSED BY AN ITEM IN THE ABOVE TABLE, WHICH COULD HAVE BEEN CLEARED BY THE CUSTOMER, THEN YOU MAY BE LIABLE FOR THE COST OF THE SERVICE CALL.**



***My garments are looking grey and there are limescale deposits present in the drum of my washing machine.***

- There is not enough detergent being added.
- The incorrect detergent is being used.
- Stains are not being pre-treated.
- The correct wash program or wash temperature was not selected.



***I have followed the advice given above, but my garments are still coming out with grey stains on them.***

- The garments are soiled with oils, ointments or grease and were washed without enough detergent.
- The wash temperature selected was too low.
- Fabric conditioner has come into contact with the garments. If this happens try to wash out these stains as quickly as you can and try to avoid getting conditioner on the garments in the future.



***After the final rinse, I can still see foam.***

- Modern detergents can result in there still being foam in the final rinse. This does not mean that the washing is not being rinsed properly.



***There is white residue on my garments when I remove them from the appliance.***

- Modern detergents can contain insoluble contents, and white residue after a wash cycle is not necessarily a sign of the garments not being rinsed properly.
- You should shake out the garment or brush it off. In future possibly turn the garment inside out before it is washed. You may wish to move from a powder detergent and switch to a liquid detergent instead.

## Installation



**IMPORTANT: THIS INSTALLATION MUST BE COMPLETED BY A SUITABLY QUALIFIED PERSON. BAUMATIC ONLY SANCTION THE INSTALLATION GIVEN IN THIS INSTRUCTION MANUAL. YOU SHOULD KEEP THE TRANSIT PACKAGING, IN CASE YOU NEED TO TRANSPORT THE MACHINE IN THE FUTURE.**

### Unpacking the machine and removing the transit bolts

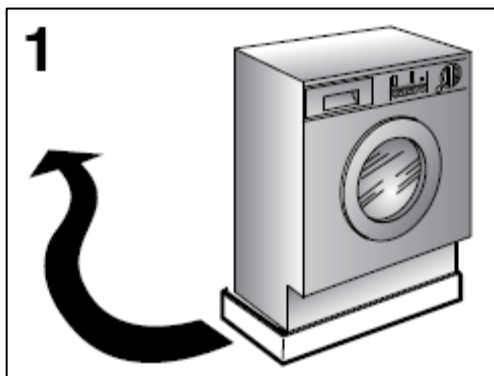

- Remove the polystyrene base and place the machine near its permanent position **(1)**.

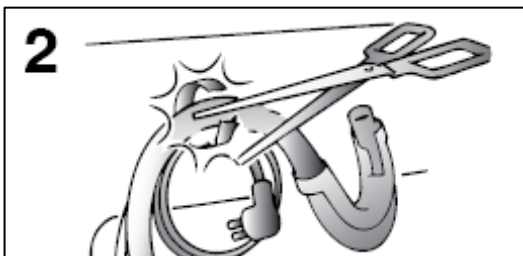

- Carefully cut through the hose retaining clip at the rear of the appliance, taking care not to cut the hose **(2)**.

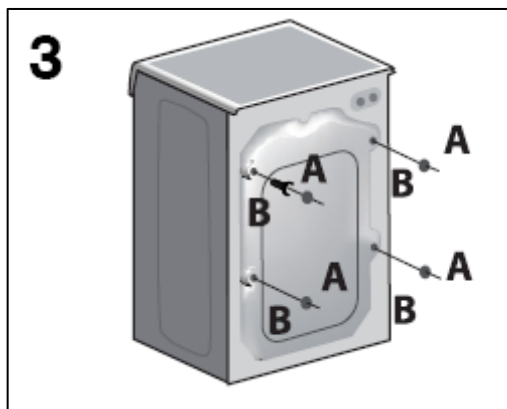

- Remove the 4 fixing screws **A** and remove the spacers **B** **(3)**.
- It is possible for the spacers to fall inside the machine so you should gently tilt the appliance to remove these.

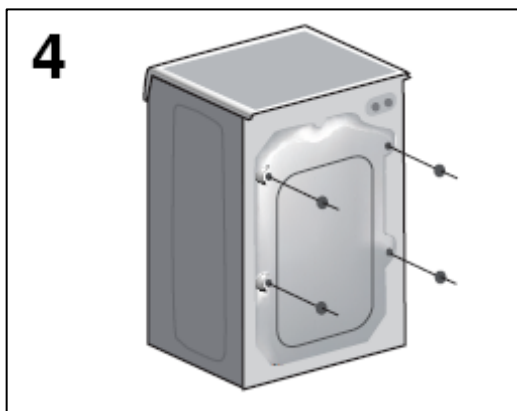

- Cover the 4 holes using the caps provided **(4)**.
- We recommend that you keep the transit bolts to immobilise the machine for future transit.

**IMPORTANT:** The transit bolts **MUST** be removed before your washing machine is used for the first time.

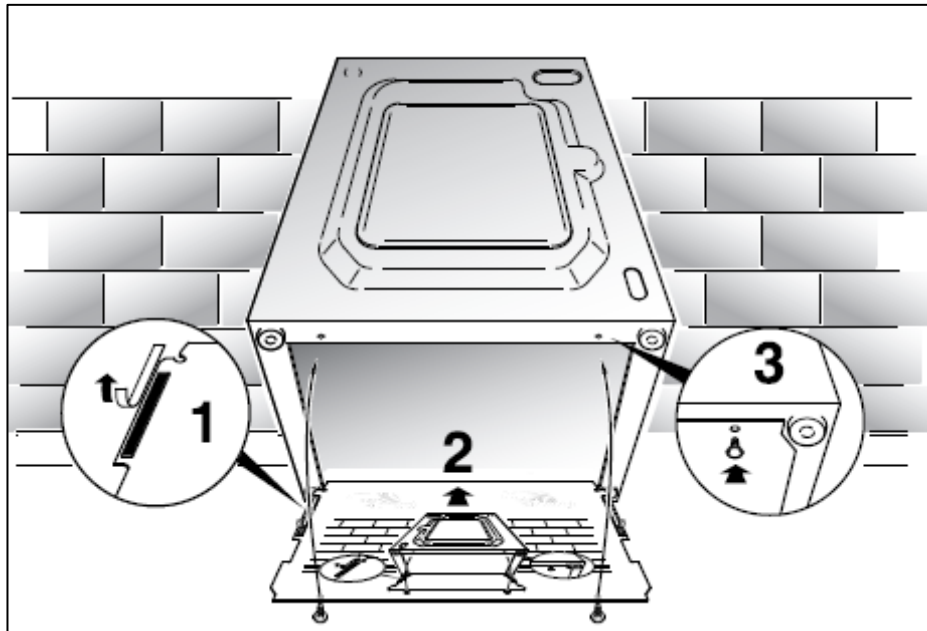

- Apply the insulation sheet or corrugated material to the base of the appliance as shown above.
- Peel back the sealing strips **(1)** and line the insulation sheet up with the base of the appliance **(2)**. Secure the sheet in place using the screws as shown **(3)**.

### Positioning and levelling the appliance

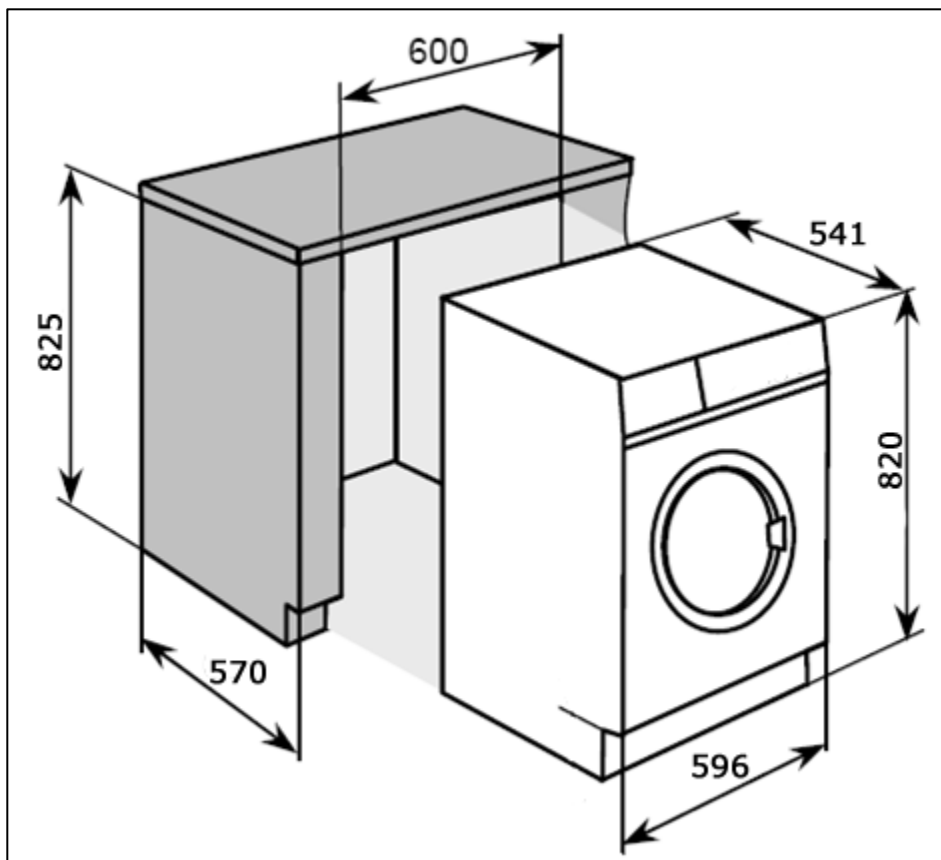

- The washing machine requires an aperture of the size given in the diagram on the previous page.
- Place the washing machine on a solid and level floor surface.
- **DO NOT PLACE THE WASHING MACHINE ON A CARPET.**
- The feet are adjustable to ensure that the appliance is level. This is essential for quiet operation.

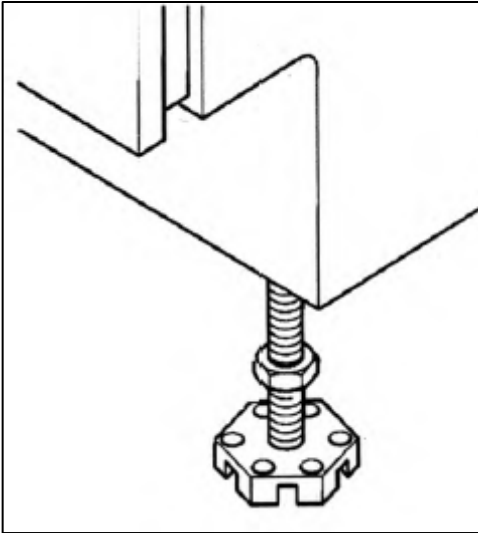

- Slacken off the lock nut on each of the washing machine feet using a spanner.
- Adjust the feet to level off the washing machine.

- Once levelled correctly, you should tighten the lock nut back up on each of the washing machine feet using a spanner.

**IMPORTANT:** When the washing machine is positioned in the location where it will be used. Make sure that all four feet are resting firmly on the floor, by pressing down on each corner and checking that the appliance stands still.

### Fitting the décor door

- The front of the appliance has been drilled to accommodate the hinges to enable the door to be opened from the left or right hand side.
- The following instructions demonstrate how to fit a standard height décor door with dummy drawer.

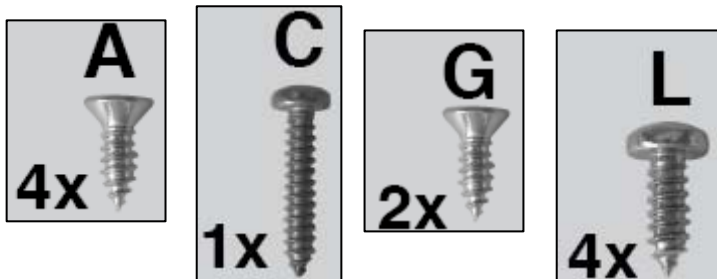

- You will need these screws to complete the fitting.

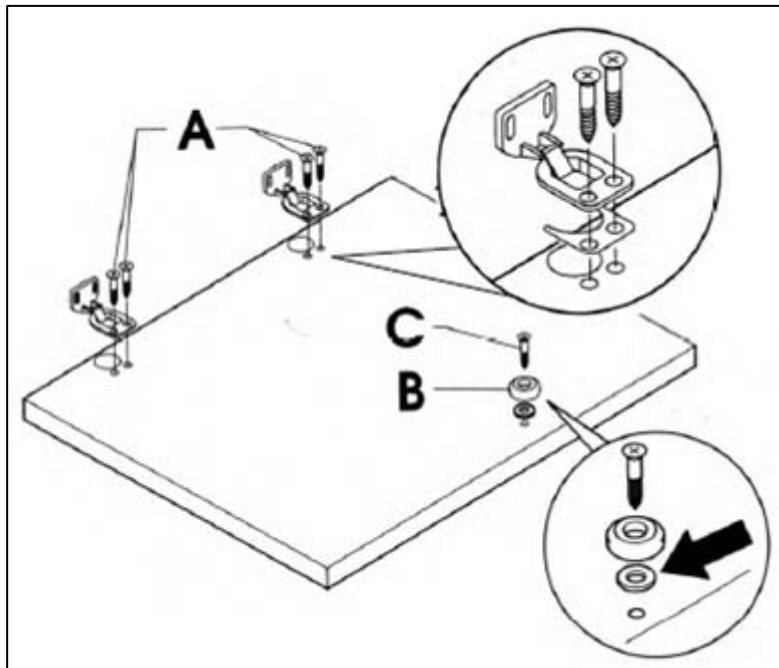

- Screw the hinges onto the décor door (**A**) then fasten the dummy drawer front to the top edge of the door. Ensure that the gap between the door and drawer front matches the units on either side.
- Fasten the magnetic catch (**B**) using screw (**C**) to the décor door.

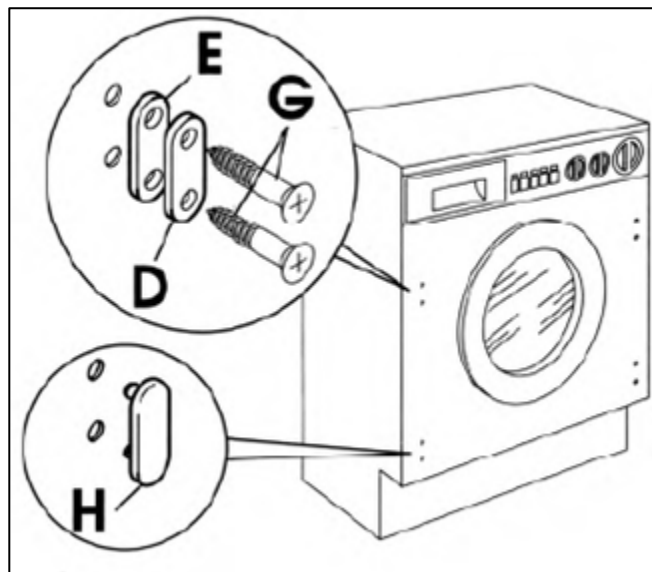

- Fasten the magnetic catch striker plate (**D**) to the front of the appliance, placing the rubber washer (**E**) under the plate and screw in place with screws (**G**).
- Snap mount the plastic cover cap (**H**) into the lower hinge position.



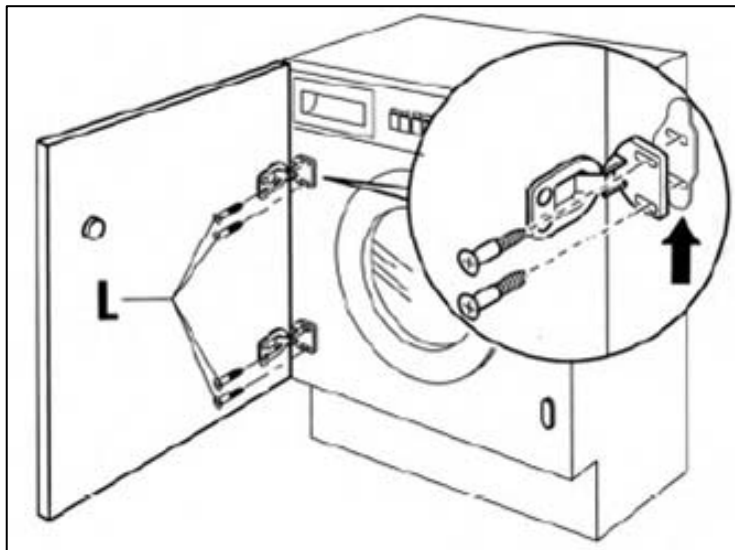

- Mount the door and hinges to the front of the appliance using screws (L).
- **IMPORTANT:** *It is recommended that, where possible, the décor door is hinged on the same side as the appliance door as this will give greater space to load and unload the washing.*

### Connecting to the mains water supply

- Connect and fully tighten the inlet hose to the threaded inlet valve that is located at the rear of the washing machine. You should connect the end with the right angle connector on it to the back of your appliance.

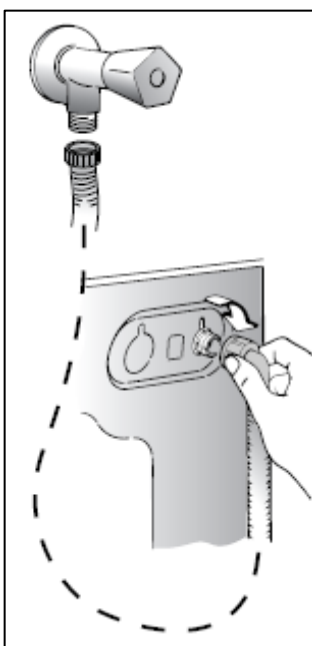

- Connect the other end of the inlet hose to your mains water supply. This machine only uses cold water therefore only one hose is needed to connect to the cold water supply. **DO NOT CONNECT TO A HOT WATER SUPPLY.**
- Tighten the inlet hose to your mains supply fully.
- Test for any leaks.

## Water outlet

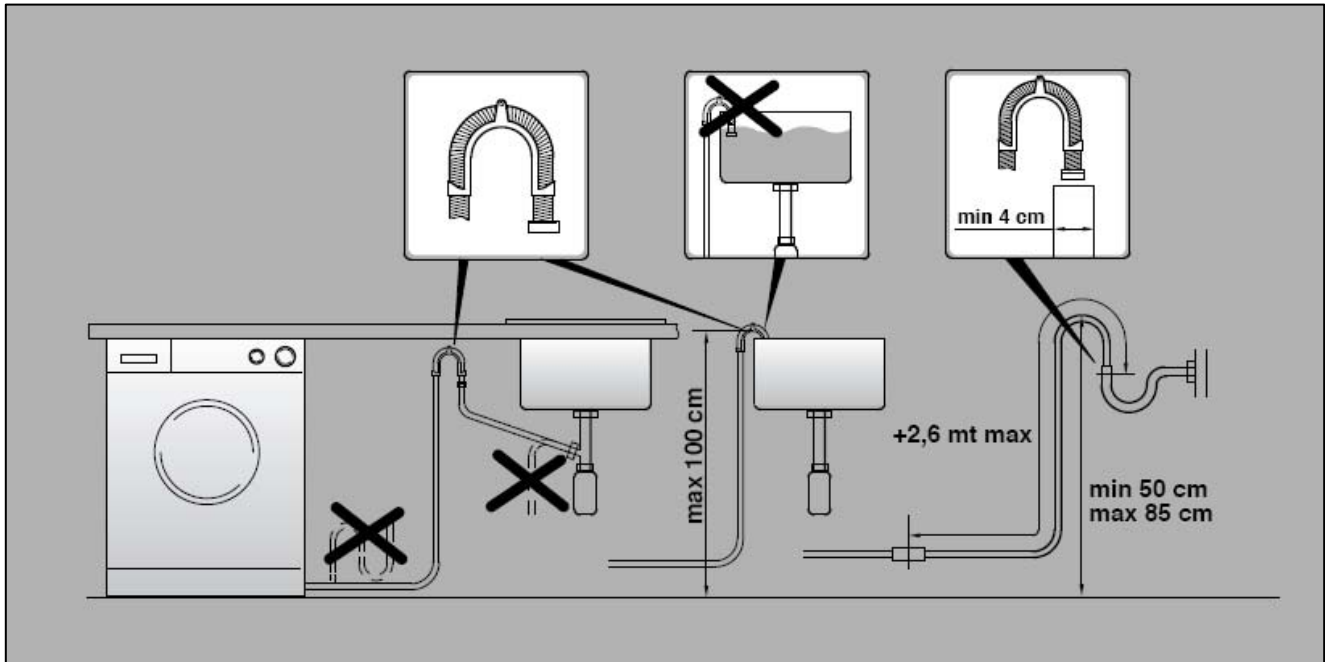

- Secure the drain hose, so that it cannot move whilst the washing machine is in use.
- Place the end of the drain hose on your drain pipe. Push it a short way down into your drain pipe.
- **IMPORTANT:** Do not insert the drain hose too deeply into the water pipe, as this may cause siphoning.
- **NEVER EXTEND THE DRAINAGE HOSE FROM ITS ORIGINAL LENGTH.**
- For the washing machine to function properly, the end of the discharge hose must be at a minimum of 50 cm and a maximum of 85 cm from the ground.

## Power supply

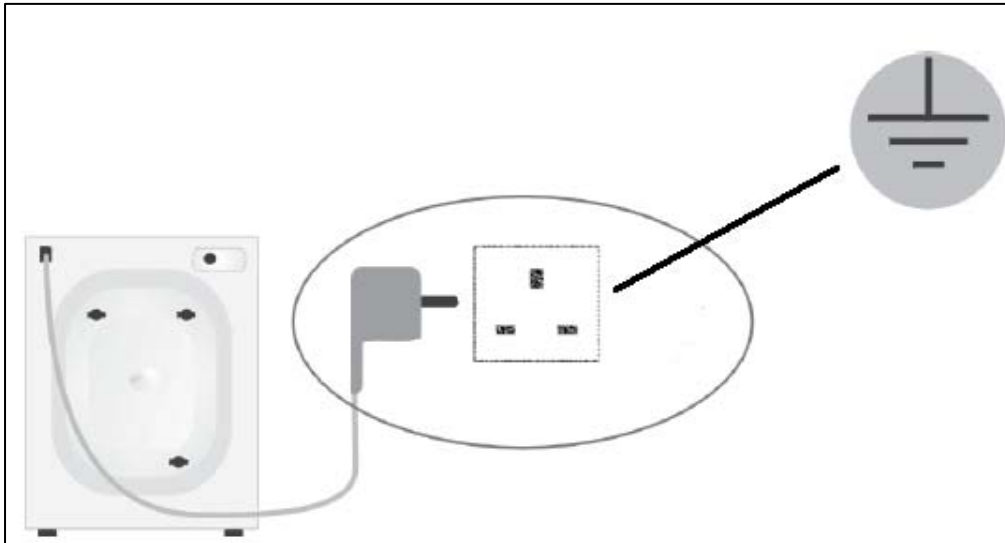

- **IMPORTANT:** As your appliance is a built in product, the electrical socket must still be accessible once the appliance is installed.
- Consult the rating plate, located on the inner rim of the porthole door of the appliance **BEFORE** making the electrical connections. Ensure that the voltage reaching the plug is the same as that on the rating plate.
- **DO NOT REMOVE THE RATING PLATE AS THE INFORMATION ON IT IS IMPORTANT.**
- The moulded plug that is supplied with the appliance must be placed into an earthed and insulated socket.
- Broken or damaged power leads must only be replaced by a suitably qualified person. A power lead of a similar type must be used in replacement.
- Power lead type – H 0 V V – F 3G 1,5.
- **IMPORTANT:** We do not recommend that this appliance is connected to an extension lead.

## Before first use maintenance wash

- When your washing machine has been correctly installed, we recommend that you perform a maintenance wash cycle.
- This will check that all aspects of the installation are correct; it will also remove any deposits that may have been left in the drum by the manufacturing process.

- Select the Cotton 90°C wash program.
- A small quantity of detergent should be used during this maintenance wash.



***IMPORTANT: If your appliance appears not to be operating correctly, then you should disconnect it from your mains supply and then contact Baumatic Customer Care on telephone number (0118) 933 6911.***

***DO NOT ATTEMPT TO REPAIR THE APPLIANCE YOURSELF.***

Please note that if an engineer is asked to attend whilst the product is under guarantee and finds that the problem is not the result of an appliance fault, then you may be liable for the cost of the call out charge.

***The appliance must be accessible for the engineer to perform any necessary repair. If your appliance is installed in such a way that an engineer is concerned that damage will be caused to the appliance or your kitchen, then he will not complete a repair.***

***This includes situations where appliances have been tiled in, sealed in with sealant, have wooden obstructions placed in front of the appliance, like plinths. Or any installation other than the one specified by Baumatic Ltd. has been completed.***

Please refer to the conditions of guarantee that appear on the warranty card that you receive with the appliance.



***United Kingdom***

Baumatic Ltd.,  
Baumatic Buildings,  
6 Bennet Road,  
Reading, Berkshire  
RG2 0QX  
United Kingdom

**Sales Telephone**

(0118) 933 6900

**Sales Fax**

(0118) 931 0035

**Customer Care Telephone**

(0118) 933 6911

**Customer Care Fax**

(0118) 986 9124

**Spares Telephone**

(01235) 437244

**Advice Line Telephone**

(0118) 933 6933

**E-mail:**

sales@baumatic.co.uk  
customercare@baumatic.co.uk  
spares@baumatic.co.uk  
technical@baumatic.co.uk

**Website:**

www.baumatic.co.uk

***Republic of Ireland***

**Service Telephone**

1-890 812 724

**Spares Telephone**

091 756 771

***Czech Republic***

Baumatic CR s.r.o.  
Lípová 665  
460 01 Liberec 4  
Czech Republic

+420 483 577 200

www.baumatic.cz

***Slovakia***

Baumatic Slovakia, s.r.o.  
Galvániho 7/D  
Slovakia

+421 255 640 618

***Germany***

Baumatic Gmbh  
Lilienthalstrasse 1  
320 52 Herford  
Deutschland

+49 5221 694 99-0

www.baumatic.de

***Italy***

Baumatic Italia S.R.L.  
Via Galvani N.3  
35011 Campodarsego (PD)

+3904 9920 2297

www.baumatic.it

***Holland***

Baumatic Benelux B.V.  
Grindzuigerstraat 22  
1333 MS ALMERE  
Nederland

+3136 549 1555

www.baumatic.nl





