

GT 755 - GT 756

Slot-in Natural Gas Double Cavity Cooker

INSTALLATION AND USER INSTRUCTIONS

Note:

These appliances are supplied for use with the category of gas specified (Natural Gas I2H) and cannot be converted to any other gas.



Contents

Introduction	3
Installing Your Cooker	4-8
For your own safety - Never	9
-Always	10
Know your Cooker / Specification.....	11
Using the Timer (GT 756)	12
3 Button LED Clock/Minute Minder	12
Minute Minder Operation.....	13
Know your Control Panel.....	14
Using the Hob	
General Notes on Safety.....	14
The Hob Glass Lid / Burner operation / Advice on pan suitability.....	15
Energy Saving Tips.....	15
Safety Requirements for Deep Fat Frying (IMPORTANT).....	16
Safety advice in case of a chip pan fire / Choosing your utensils.....	16
Using the Grill	
GT 755 & GT 756 Grill Operation.....	17
Grilling Guidelines / Use of the Grill Pan Handle	18
Using the Ovens	18
Shelf Positions/Use of the Ovens/Oven Lamp Operation (GT 756).....	19
Temperature Conversion.....	20
Main Conventional Oven Cooking Guide.....	20
Top Conventional Oven Cooking Guide (GT 756).....	20
Care and Cleaning/Replacing the Oven Lamp.....	21-22
Something Wrong With Your Cooker	23
Customer Care.....	Back Cover

This appliance conforms to the following EEC Directives:

Gas Appliance Directive:-
EN 30

Low Voltage Directive:-
73/23/EEC
93/68/EEC

Electromagnetic Compatibility:-
89/336/EEC
92/31/EEC
93/68/EEC



Introduction

Your Belling Cooker

Thank you for purchasing a new Belling GT 755 & GT 756 Gas Cooker. It's stylish and practical design will enhance your kitchen and make cooking a pleasure.

The GT 755 model features a conventional main oven, a grill and a hob with 4 gas burners.

The GT 756 model features a conventional main oven with light, a top conventional oven/grill, a hob with 4 gas burners and a clock/minute minder.

Even if you have used an electric or gas cooker before, it is important that you read these instructions thoroughly before starting to cook, paying particular attention to the installation and safety instructions.

Getting Help

If you have any problems with installing, operating, or cooking with your Belling Cooker, please check through these instructions thoroughly to make sure that you have not missed anything. If you still need help, then please contact (including a daytime telephone number if possible):

Belling Customer Care Centre
Stoney Lane
Prescot
Merseyside
L35 2XW
Tel: 0844 815 3746

Please quote the cooker model and serial number with all enquiries. This can be found on the rating plate on the plinth below the main conventional oven.

WARNING! For your own safety, make sure that these instructions on installation, use and maintenance are followed.

We advise you to keep these instructions in a safe place for future reference. If you sell or transfer ownership of this product, please pass on these instructions to the new owner.

Installing your cooker

Unpacking After unpacking your cooker, make sure that you remove all the packing from the ovens and grill, and any stickers from the oven doors and hob.
Examine your cooker. Make sure there is no damage or missing items.
If there is anything damaged or missing, please contact your supplier for advice.

Sitting/Moving the Cooker Prior to installation, ensure that the local distribution conditions (nature of the the Cooker gas and gas pressure) and the adjustment conditions are compatible. The adjustment conditions for this appliance are stated on the rating label, which is fitted on the plinth.
This appliance is not designed to be connected to a combustion products evacuation device. It must be installed and connected in accordance with current installation regulations. Particular attention should be given to the relevant requirements regarding ventilation.

Gas installation **The appliance is factory set for use with Natural Gas ONLY G20 at 20mbar.**
It is not convertible to any other gas.

Gas Safety (Installation and Use) Regulations

It is the law that all gas appliances are installed by competent persons in accordance with the current edition of the above regulations. It is in your interest and that of safety to ensure compliance with the law.
In the UK, CORGI registered installers work to safe standards of practice.
This appliance must be installed and connected in accordance with current installation regulations. Failure to install the cooker correctly could invalidate the warranty liability claims and could lead to prosecution.

Location The cooker may be located in a kitchen, kitchen/diner or a bed-sitting room, but not in a room containing a bath or shower. The cooker must not be installed in a bed-sitting room of less than 20m².

Levelling The appliance should be located on a level surface. The front/rear feet can be adjusted to a maximum height of 910mm as required. To ensure that your appliance is standing level, adjust the rear feet by turning clockwise or anticlockwise until the rear of the product is set to the required height. Position the cooker in the correct location and adjust the front feet by turning clockwise or anticlockwise to ensure firm contact with the floor. Check the cooker is level using a spirit level (Not provided). Adjust if necessary.

Provision for Ventilation The room containing the cooker should have an air supply in accordance with current regulations in force.
The room must have an opening window or equivalent; some rooms may also require a permanent vent. If the room has a volume between 5 and 10m³, it will require an air vent of 50 cm² effective area unless it has a door which opens directly to outside. If the room has a volume of less than 5m³, it will require an air vent of 100 cm² effective area. If there are other fuel burning appliances in the same room, current regulations should be consulted to determine air vent requirements.

Space for THIS APPLIANCE MUST NOT BE INSTALLED ON A NON-FIXED RAISED BASE.

Fixing

To ensure that critical air gaps are maintained under the product, we recommend that this product is mounted on a solid base and that the feet do not sink into any carpet or soft flooring.

The cooker is designed to slot between standard kitchen units spaced a minimum 500mm apart. The clearance either side need only be sufficient to allow the cooker to be withdrawn for servicing.

It can be used with cabinets on either side but for a minimum distance of 400mm above hotplate level allow a side clearance of 60mm between the appliance and any wall, partition or tall cupboard. It can also be used in a free standing position.

Allow a minimum distance of 750mm from the hob surface to the underside of any overhead combustible surface such as overhanging cabinets.

Your cooker is heavy, so be careful when moving or positioning it. Do not try to move the cooker by pulling on the doors or handles.

To avoid damage to surrounding units a 10mm gap should be left between the appliance and the units. If this is not possible, a kit (part number 01 25552 00) may be ordered from Customer Care which will protect the units.

For models with side opening doors, we recommend a side clearance of 60mm between the cooker and any side wall to allow the door to be opened fully.

Whatever the position, remember to leave enough room for the cooker to be pulled out for cleaning and service.

Movement of your cooker is most easily achieved by lifting the front as follows and pulling forwards. Open the Grill door and the Conventional Oven door sufficiently to allow a comfortable grip on the underside front edge of the oven roofs, avoiding any grill elements or oven interior furniture. Take care not to damage any floor coverings.

If a cooker hood is to be fitted, refer to the manufacturer's instructions regarding fixing height.

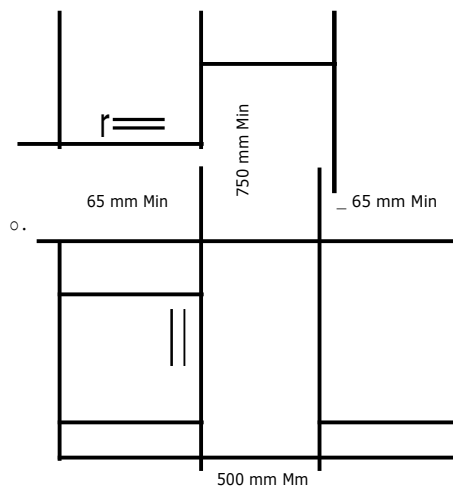

WARNING

The use of a gas cooker results in the production of heat and moisture in the room in which it is installed. Ensure that the kitchen is well ventilated; keep natural ventilation holes or install a mechanical ventilation device (mechanical cooker hood)

Prolonged intensive use of the appliance may call for additional ventilation, for example opening of a window, or more effective ventilation, for example increasing the level of mechanical ventilation where present.

Connecting to This appliance is designed not to project in front of standard 600mm

Gas Supply

worktops (excluding handles). To achieve the best fit the cooker must be pushed against the wall. If the wall mounted adapter backplate (Fig.1) is to be fitted behind the appliance then the suitable area for this fitting is shown as the area in (Fig.2).

The temperature rise of areas at the reara of the cooker that are likely to come into contact with the flexible hose do not exceed 70°C. However, do not allow contact of the hose in the top 150mm/6 inches (the shaded area shown in Fig.3).

A Rp 1/2 union is fitted to the cooker. Connection to the appliance should be made with an approved appliance flexible connection to BS669. The length of the hose should be such that when the cooker is in situ, it does not touch the floor.

Stability Chain The cooker must be secured by a security chain to the wall or partition behind the cooker. (Fig.4)

Flame Failure Device

All burners are protected by flame failure devices, if the flames are extinguished for any reason the gas will automatically be cut off.

The burner control knobs have a safety feature.



Flame failure device

1 Push the appropriate knob in slightly and turn anti-clockwise to the required setting.

2 While keeping the knob depressed press the ignition button. /4;

3 Keep the knob depressed for 15 seconds after the burner has lit to override the safety device.

If still no ignition occurs, wait for 1 minute and repeat again.

Warning: Do not keep the knob in pressed position more than 15 seconds.

4 To switch a burner off turn the corresponding knob to I.

- Turning the control knob fully anti-clockwise to the small flame symbol enables you to simmer without accidentally switching off.

Fig.1

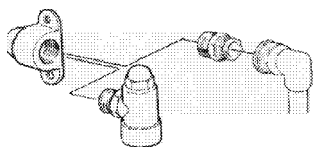

Fig.2

A=150
B=175
C=700
D=500
E=150

Fig.3

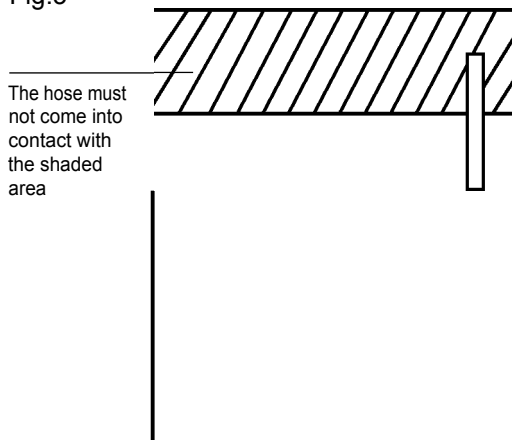
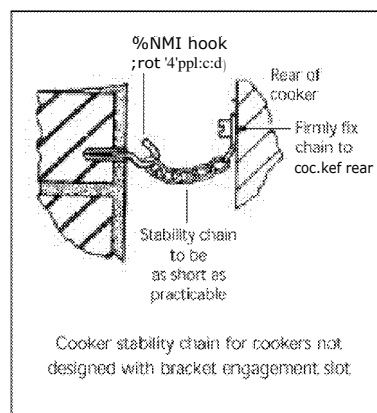

Fig.4



Electrical Connection Connection to the electricity supply should be made via a properly earthed, readily accessible wall socket which is adjacent to and not more than 1.25m away from the appliance. The socket must be capable of electrical isolation. The mains lead should be routed such that it cannot touch hot parts of the cooker i.e. the back panel above a height of 650mm from the floor.

Legal Requirements

Should this plug not fit the socket outlet in your home it should be cut off and replaced with a suitable plug as outlined below.

IMPORTANT NOTE: The severed plug cannot be used for any other appliance and should therefore be properly disposed of in a safe manner. **DO NOT LEAVE** where children might find it and plug into a supply socket - This is an obvious hazard and extremely dangerous.

We recommend that the appliance is connected by a competent electrical installer, who is a member of a recognised "competent persons" scheme and who will comply with the I.E.E. and local regulations.

Where a fixed connections is used, a device allowing the appliance to be isolated on all poles from the mains supply with a contact opening width of at least 3mm must be provided.

This appliance must be earthed.

Important: Ensure that you route all mains electrical cables well clear of any adjacent heat source, such as an oven or grill.

If the Fitted Plug is Removed

The flexible mains lead must be correctly connected as below to a three pin plug of not less than 13amp capacity. If a BS 1363 plug is used, then it must be fitted with a 3amp fuse approved to BS 1362.

IMPORTANT: The wires in the mains lead fitted to this appliance are coloured in accordance with the following code:

- GREEN AND YELLOW - Earth
- BLUE** - Neutral
- BROWN - Live

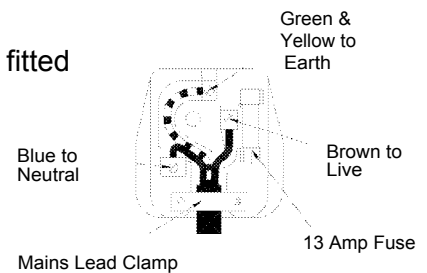

As the colours of the wires in the mains lead of this appliance may not correspond with the coloured markings identifying the terminals in your plug, proceed as follows:- The wire which is coloured green and yellow must be connected to the terminal in the plug marked with the letter 'E' or by the earth symbol or coloured k green or green and yellow. When connection is completed, close the terminal block, ensuring the cover is engaged on the locking tabs.

The wire coloured blue must be connected to the terminal marked with the letter 'N' or coloured black. The wire coloured brown must be connected to the terminal marked with the letter 'L' or coloured red. When wiring the plug, ensure that all strands of wire are securely retained in each terminal.

Do not forget to tighten the mains lead clamp on the plug. As the appliance must be earthed, do not use 2-pin socket outlets. If you are in doubt, consult a qualified electrician. Should the mains lead ever require replacement, it is essential that this operation be carried out by a suitably qualified electrician and should only be replaced with a flexible cord of the same size i.e. 0.75mm² cross sectional area and temperature rating of 85°C e.g. heat resisting PVC.

After connection to the electricity supply please check that all electrical parts of the appliance are working.

The maximum power rating is specified in the Technical Data of this handbook and also on the Data Label on the appliance.

If a Moulded Plug is Fitted

In the event of replacing a fuse in the plug supplied, a 13amp ASTA approved fuse to BS 1362 must be fitted.

NOTE: The fuse cover must be refitted when changing the fuse. In the event of losing the fuse cover, the plug must not be used until a replacement fuse cover has been obtained and fitted. A new fuse cover can be obtained from your local electrical retailer. The colour of the correct replacement fuse cover is that of the coloured marks or inserts in the base of the plug.

Operational Checks

After installation check for gas soundness.

Assemble burner caps and rings; fit pan supports in position.

Turn on the gas supply and check for soundness at the hotplate injector. Light two burners and check that the pressure is correct.

Before you cook for the first time, we recommend that you light each burner in turn to burn off any odours remaining from manufacture. Simply operate the grill on maximum for a few minutes and the oven(s) for approximately 30 minutes. Ensure that the room is well ventilated (e.g. open a window or use an extractor fan) and that persons who may be sensitive to the odour avoid any fumes. It is suggested that any pets be removed from the room until the smell has ceased.

Instruct the user on the operation of the cooker.

For your safety

When used properly your Belling GT 755,GT 756 Gas cooker is completely safe, but as with any electric or gas appliance there are some precautions you must take in its use.

Never..

- Never allow anyone except an authorised Belling Service Agent to service or repair your cooker.
- Never remove any part of the cooker other than those intended in normal use, or attempt to modify the cooker in any way.
- Never use the cooker for commercial catering. It is designed for domestic use and for cooking food only.
- Never allow young children to operate or play with the cooker, as all surfaces get hot while in use.
- Never allow children to sit or stand on any part of the appliance.
- Never store items above a cooker that children may attempt to reach.
- Never use a chip pan or deep fat fryer more than 1/3 full of oil, or use a lid while frying, and do not leave a fryer unattended while cooking.
- Never operate the grill with the grill/top oven door closed. This may cause overheating of your cooker.
- Never line the shelves, floor, or sides of the oven or grill, with aluminium foil as overheating and damage may result.
- Never place materials which might catch fire, such as tea towels on the hob or elements, even when the cooker is not in use.
- Never allow aluminium foil or plastic to touch any hob element when it is hot.
- Never use an asbestos mat, trivet or rack of any kind under pans on the hob.
- Never store anything which might catch fire in the oven or grill.
- Never heat unopened containers.
- Never place flammable or plastic items on or near the hob.
- Never dry clothes on either hob or oven doors.
- Never store flammable liquids, aerosols, etc. in adjacent cabinetry.
- Never use large preserving pans or fish kettles across two hotplates as this will damage the hob.

For your safety

Always..

- Always take care when touching any part of the cooker which may be hot. Use dry oven gloves when removing or replacing food or dishes. Care should be taken to avoid touching the heating elements inside the oven.
- Always stand back when opening the oven door to allow any build-up of heat or steam to disperse.
- Always keep the oven and grill doors closed when not in use to prevent accidents, but remember that the grill door must be kept open when grilling to prevent overheating.
- Always make sure that the roof, side and back panels, and shelves are fitted correctly before using the oven or grill.
- Always keep your cooker clean, as a build-up of grease or fat from cooking may be a fire hazard.
- Always switch off at the mains supply and allow the cooker to cool before cleaning your cooker.
- Always supervise children and pets, particularly when grilling, as exposed parts of the cooker may become hot.
- Always place pans centrally over the hotplate burners, and position them so that the handles cannot be accidentally knocked or become heated by other burners.
- Always keep handles away from the edge of the hob. For added safety you should consider using a suitable hob guard.
- Always make sure that all the controls are switched off when you finish cooking.
- Always remember that your cooker may stay hot for a time even after you have finished cooking.
- Always keep ventilation slots clear of obstructions.
- Always keep children away from cooker when cleaning at maximum oven setting.

Know Your Cooker

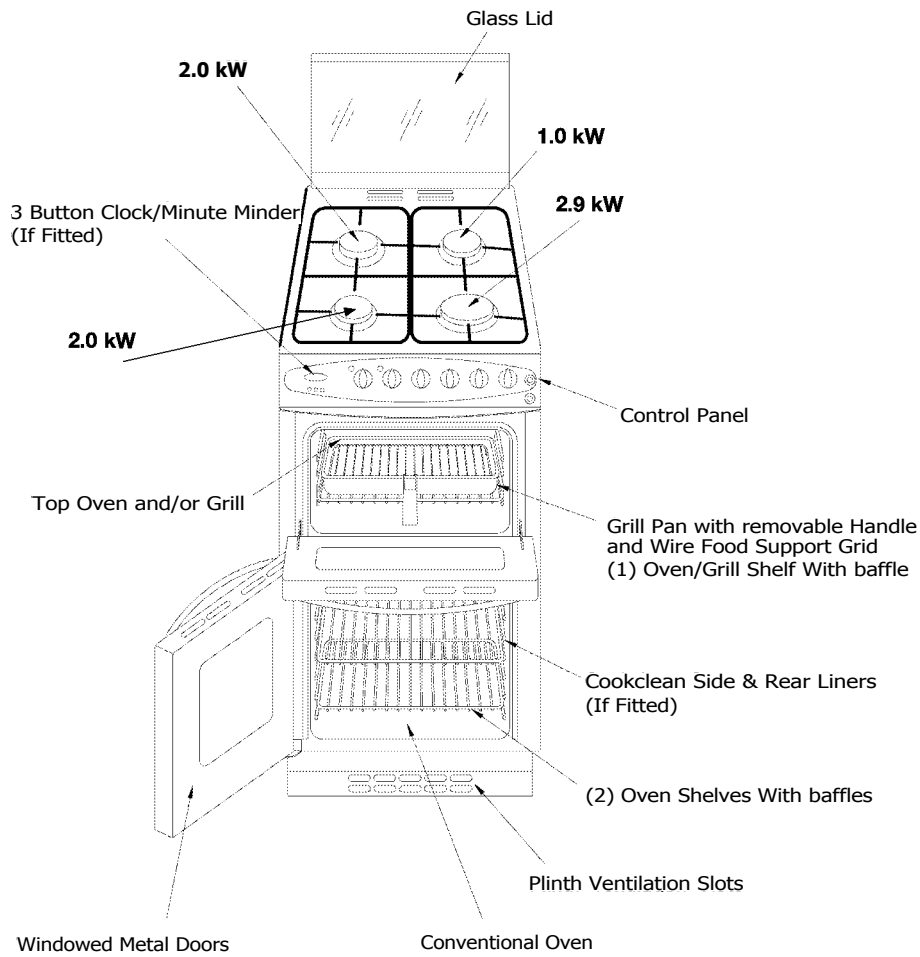

Specification				
Supply Voltage	230 V AC		Ignition	Push Button Electric
Supply Frequency	50 Hz		Safety Device	Gas valves are lockable and Flame Failure Devices
Maximum Wattage	GT 755	Electric=0.02 kW	Unpacked	H: 900 mm
	GT 756	Electric=0.06 kW		
Grill Wattage			External Dimensions	W: 500 mm D: 600 mm
	Gas = 12.7 kW			
Top Oven Wattage	GT 756		Packed	H: 985 mm
Conventional Oven Wattage	GT 755			
Conventional Oven Wattage	GT 756 inc 25W-230V Lamp		External Dimensions	W: 560 mm D: 700 mm
Rear Left Burner				
Front Left Burner				
Front Right Burner				
Rear Right Burner				
			Grill Area	800 sq cm

Gas	Supply Pressure	Destination Countries
G 20	20 mbar	GB

I 2H AT 20 mbar

Cat I 2H

Because we continually strive to improve our products, we may change our specifications and designs without prior notice.

Using the timer (G756 Only)

3 Button LED Clock/Minute Minder

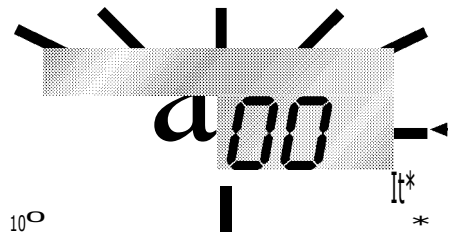

To Set Time of Day

- Step 1 Check that the electricity supply to the cooker is turned on.
- Step 2 When switched on the display will show 0.00 flashing intermittently.

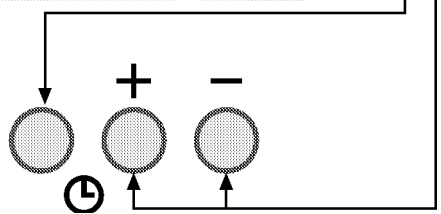
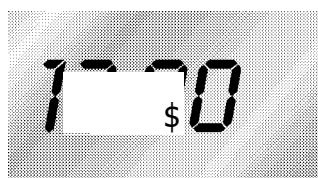

- Step 3 Press the "1" button and then press either the "+" or "-" buttons to set the correct time of day.

Note: If the electricity supply has been off, the "+" button must be pressed once before the "-" button, if it is required to reduce this time of day.

THE TIME OF DAY IS NOW SET.

Minute minder operation

To Set the Minute Minder

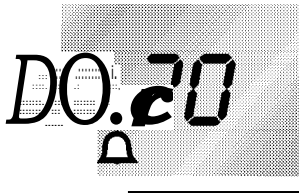

Step 1 Press the button until the required time is set. A "Bell" symbol will light up. During setting the time adjusts in 10 second intervals up to a maximum of 99mins 50secs.



It can also be adjusted by pressing the "2" button.

At the end of the set time, a bleeping sound will be heard and the "Bell" will disappear.

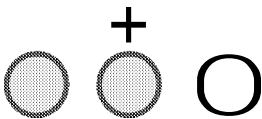
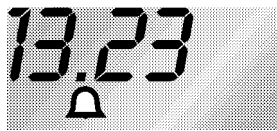

The bleeper can be cancelled by pressing the "+" button.

NOTE: If necessary the minute minder can be cancelled before the bleeper sounds by pressing the "+" and "-" buttons together until 0.00 appears in the display window.

To adjust the pitch of the bleeper, press the "2" button while the bleeper is sounding. For example:

- Press the "+" button and set 10 seconds.
- When the bleeper sounds, press and release the "2" button, until preferred pitch is set.
- Press and release the "+" button to cancel the bleeper.

If a temperature is selected for the main oven first the oven will switch off after the set period.

Know your Control Panel

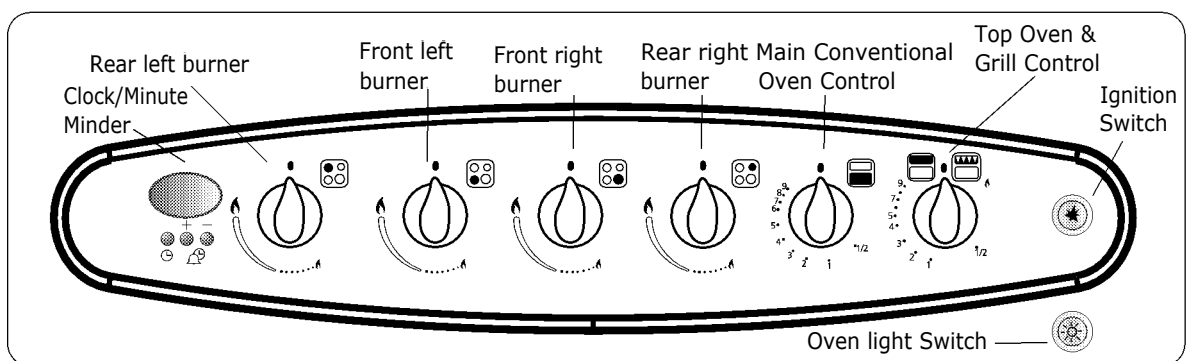
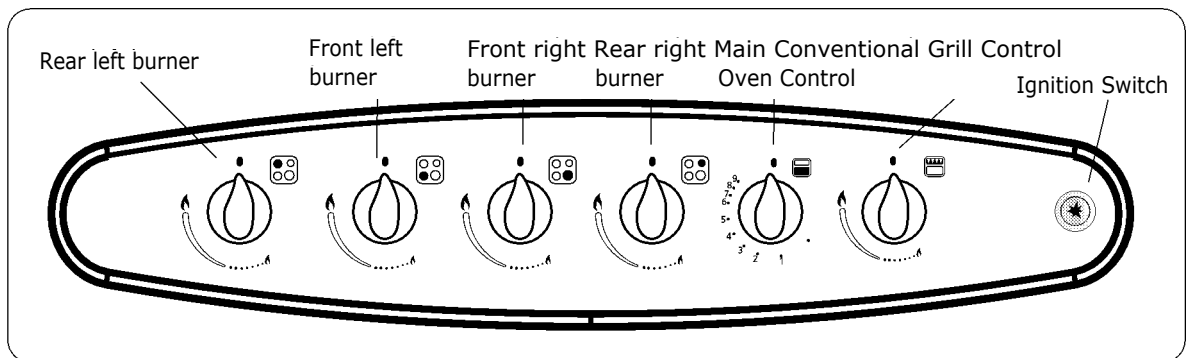

Using the Hob

GENERAL NOTES ON SAFETY

- 1 When the hob is in use do not leave unattended and make sure there are no small children in the vicinity. Check that pan handles are positioned correctly and always keep an eye on the pan whenever oils or fats are used, as they are easily immflamable.
- 2 Do not use spray cans near the appliance when it is in use.
- 3 Even after use, surfaces retain heat for a long time so do not put your hands or other objects on them.
- 4 After you have used the appliance make sure that all the controls are in the OFF position.

The Hob Glass Lid

The hob glass lid on the cooker is toughened for your protection and safety. Before opening it remove any food deposits from its surface. The glass lid is purely decorative and is not intended as a work surface and should not be used for this purpose. As with any glass surface care must be taken to avoid scratches or damage, as this may result in the glass breaking. The glass lid incorporates a safety valve that shuts off the gas supply to the four hob burners, when the lid is lowered.

The oven(s) and grill will still operate with the lid in its closed position. Do not use this facility as a means of controlling the burners. This device is fitted in the interests of safety.

WARNING: Always make sure that all the control knobs are in the **OFF** position and the burners have cooled before the hob lid is closed. Failure to do so could result in damage to the lid and a risk of personal injury.

Please note that if the gas taps have not been turned off, the **supply of gas** to the hob burners will **restart** when the hob is lifted and **will not** re-light until a spark or flame ignites them.

Burner operation

1. Check that the electricity supply is switched on.
2. Ensure the glass lid is in its open (Upright) position. Select the burner to be used. Push in and turn the control knob anti-clockwise to the large flame symbol. Press the ignition button until the burner lights (Or manual ignition by match, taper or other auxiliary methods may be used). Turn the control knob to the required setting. A simmer position is achieved when the control knob is turned fully anti-clockwise.
3. To turn off, turn the control knob fully clockwise to the '0' symbol.

Advice on Pan Suitability

Do not use pans which are unstable when placed on a flat work top. The use of split pans, i.e. those comprising two or more pans designed to fit together over a single burner, is not recommended as these can be unstable on the hotplate. In order to get best value out of your hob, the following economy tip is recommended. Choose the correct burner for the size of pan e.g. 18cm (for auxiliary burner), 20cm (for semi-rapid burner) and 22cm (for rapid burner).

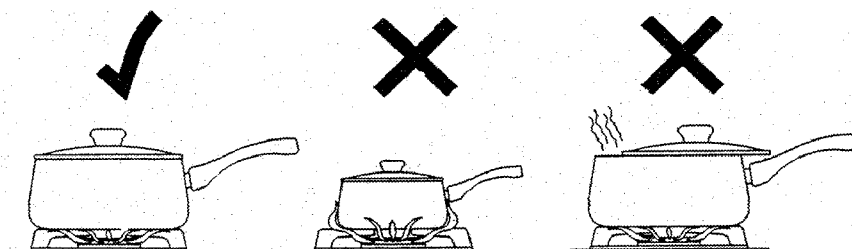

Energy Saving Tips

1. Do use saucepans with lids.
2. Place pans centrally over burner.
3. Do not allow flames to lick up the sides of the pan.
4. Only fill kettles or pans with the amount of liquid needed.
5. Turn down the gas as soon as the contents of the pan boil.
6. Do not light the burner until the pan is in position and turn off before removing the pan.
7. Cut vegetables into smaller pieces so that they cook quicker and cook more than one vegetable in the same pan, e.g. carrots and potatoes.
8. In hard water areas de-scale kettles regularly.
9. Consider using a pressure cooker.

Safety Requirements for Deep Fat frying

IMPORTANT:

As there could be some fire risk attached to the heating of oil, particularly for deep fat frying, cooking utensils containing oil must not be left unattended (e.g. to answer the telephone) or in close proximity to hotplates. In the unfortunate event of a fire it will assist in smothering the flames if the pan lid is replaced. Turn off all the gas taps.

1. Use a deep pan, large enough to completely cover the appropriate heating area.
2. Never fill the pan more than one third full of fat or oil.
3. Never leave oil or fat unattended during the heating or cooking period.
4. Do not try to fry too much food at a time, especially frozen food. This only lowers the temperature of the oil or fat too much, resulting in greasy food.
5. Always dry food thoroughly before frying, and lower it slowly into the hot oil or fat. Frozen foods, in particular, will cause frothing and spitting, if added too quickly.
6. Never heat fat, or fry, with a lid on the pan.
7. Keep the outside of the pan, clean and free from streaks of oil or fat.

Safety advice in case of a chip pan fire

In the event of a chip pan fire or any other pan fire.

1. TURN OFF ALL THE GAS TAPS.
2. COVER THE PAN WITH A FIRE BLANKET OR DAMP CLOTH, this will smother the flames and extinguish the fire.
3. LEAVE THE PAN TO COOL FOR AT LEAST 60 MINUTES BEFORE MOVING IT. Injuries are often caused by picking up a hot pan and rushing outside with it.

NEVER USE A FIRE EXTINGUISHER TO PUT OUT A PAN FIRE as the force of the extinguisher is likely to tip the pan over.

Never use water to extinguish oil or fat fires.

Choosing your Utensils

For best results we recommend the use of good quality saucepans with smooth flat bases. Aluminium pans with coloured vitreous enamelled bases absorb heat and are therefore more efficient in use. Almost equally as good are saucepans with a thick machined aluminium base. If using enamelled steel or cast iron pans, ensure that they have good smooth flat bases as otherwise the heat will not be distributed evenly and damaging heat spots may be created.

Never use recessed or ridged base utensils. Ideally the base of saucepan should be approximately the same size as the heating area, up to a maximum of 254mm (10").

Using the grill

Parts may become hot when the grill is in use, children must be kept away.
ALWAYS ENSURE THE DOOR IS OPEN WHEN GRILLING

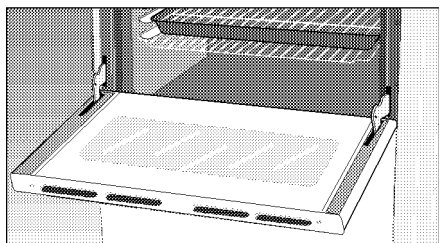

GT 755 Grill Operation

- 1 Turn the grill on by depressing and turning the grill control knob anti-clockwise to the large flame position. Depress and hold the control knob while at the same time pressing the spark ignition button until the spark lights the gas. Keep the knob depressed after the burner has lit for a further 15 seconds for the flame to establish. Allow the grill to pre-heat for around 5 mins.
- 2 Rotate the grill control knob anti-clockwise to the required setting. Only turn the control knob between the large flame symbol and the small flame symbol when adjusting the setting. (Refer to 'Grilling Guidelines' on Page 18)
- 3 To turn off, turn the control knob fully clockwise to the '0' symbol.
- 4 In the event of the burner flames being accidentally extinguished, turn off the control knob and do not attempt to re-light the grill for at least one minute.

GT 756 Grill Operation

- 1 Turn the grill on by depressing and turning the grill control knob clockwise to the large flame position. Depress and hold the control knob while at the same time pressing the spark ignition button until the spark lights the gas. Keep the knob depressed after the burner has lit for a further 15 secs for the flame to establish. Allow the grill to pre-heat for around 5 mins.
- 2 The gas flame is not adjustable. (Refer to 'Grilling Guidelines' on Page 18)
- 3 To turn off, turn the control knob fully anti-clockwise to the '0' symbol.
- 4 In the event of the burner flames being accidentally extinguished, turn off the control knob and do not attempt to re-light the grill for at least one minute.

GT 756 Grill Operation

- **Only use the bottom shelf position for grilling. Do not use any other position.**
- Ensure the food is correctly positioned under the grill burner.
- Food that requires browning only should be placed under the hot grill, either in the grill pan, or on the floor of the grill compartment, according to the depth of the dish. The grill pan wire grid can be removed.
- Do not line the grill pan with aluminum foil.
- Plates and dishes placed on the floor of the grill compartment will be heated when the main oven is in use.
- Do not switch on the grill when using the compartment for storage.
- **During use the appliance becomes hot. Care should be taken to avoid touching heating elements inside the oven.**

Grilling Guidelines

Use the following chart for guidelines.

For thicker foods requiring longer cooking, turn the control to a lower setting after the initial sealing on both sides. The thicker the food, the lower the control should be set. When grilling thicker food, the grill rack should be turned over to its lowest position.

Food	Grill Setting	Approximate Cooking time
Toasting of Bread products	Full On	3 - 10 mins.
Small cuts of meat, sausages, bacon, etc.	High to Full	15 - 20 mins.
Chops etc. Gammon steaks Chicken pieces	Med to Full	20 - 25 mins. Wire food support used in upturned position for chicken.
Fish: Fingers Whole Fillets	Med to High	10 - 20 mins. Whole fish and fillets placed in the base of the grill pan.
Fish in breadcrumbs	Med to High	15 - 20 mins.
Pre — Cooked potato products	Med to High	15 - 20 mins.
Pizzas	Med to High	12 - 15 mins. in the base of the grill pan.
Browning of food	Full On	8 - 10 mins. Dish placed directly on the base of the grill compartment

Note:- The Grill setting on the GT 756 is Full On Only. Adjust cooking times accordingly.

Use of Grill Pan Handle

Warning! Always use an oven glove to protect your hand when using the grill as all metal parts can become very hot.

The grill pan has a detachable handle. Make sure the handle is securely located between the raised profiles across the front of the grill pan. See the diagrams for fitting the handle. To remove the handle, reverse the sequence of operations.

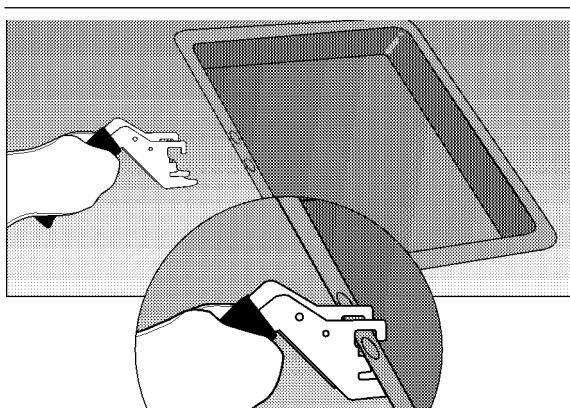

Always take care not to touch hot surfaces when using the grill panhandle. Ensure when using the grill panhandle that it is centralized and secure. Please note that the grill panhandle will get very hot during use.

Using the Ovens

Your appliance has either one or two conventional ovens. The ovens have different heat zones with the thermostat settings referring to the temperature on the middle shelf; above the shelf it is hotter and below it is cooler. The main oven has two shelves and five possible shelf positions (reference numbered 1 to 5 from the top down). The top oven (GT756 Only) has one shelf and two possible shelf positions (reference numbered 1 to 2 from the top down). The varying shelf positions allow full use of the different temperatures inside the ovens.

Shelf Positions

The shelf positions are counted from the top runner down as shown below.

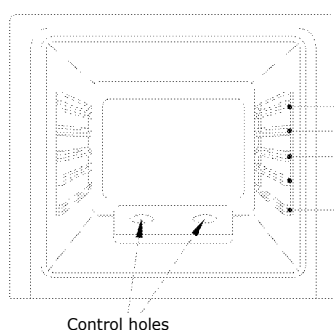

MAIN CONVENTIONAL OVEN

1
2
3
4
Shelf
Levels

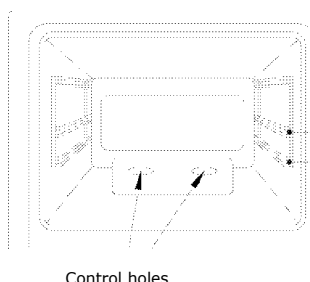

TOP CONVENTIONAL OVEN

1
2
Shelf
Levels

Use of the ovens

- 1 Open the door
- 2 Adjust the shelves to the positions required
- 3 Turn the oven on by depressing and turning the oven control knob anti-clockwise to setting 7. Depress and hold the control knob while at the same time pressing the spark ignition button until the spark lights the gas. Keep the knob depressed after the burner has lit for a further 15 seconds for the flame to establish. The flame is visible through the control holes as shown in the diagrams above.
- 4 Close the door
- 5 Select the temperature in the oven by rotating the knob to the required setting.
- 6 Allow 10 minutes for pre-heating.
- 7 **To turn off**, turn the control knob fully clockwise to the '0' symbol.
- 8 In the event of the burner flames being accidentally extinguished, turn off the control knob and do not attempt to re-light the oven for at least one minute.

Ensure you stand back from the appliance when opening the oven door to allow any build up of steam or heat to escape.

- Check food is thoroughly cooked and is piping hot before serving.
- When cooking, rotate the food and turn the food over (If suitable) approximately half way through the cooking cycle. This will ensure even cooking/baking results.

Oven Lamp Operation (GT 756)

The main oven is fitted with a 25W - 230V SES (300°C) lamp and can be illuminated by depressing the lamp switch situated on the control panel (See Know Your Control Panel Page 14).

NOTE:- The oven lamp is not covered by the guarantee. For a replacement call our Spares Department on (tel. 0844 815 3745)

Temperature Conversion

The oven temperature control markings are gas marked 0 to 9.

The equivalent degrees Celsius (sometimes called Centigrade) and degrees Fahrenheit are shown below as a guide.

Gas Mark	MAIN OVEN (Centre Oven Temperatures)		TOP OVEN (GT 756) (Centre Oven Temperatures)	
	Celcius °C	Fahrenheit °F	Celcius °C	Fahrenheit °F
1/2	110	230	110	230
1	120	250	130	265
2	150	300	140	285
3	175	350	150	300
4	195	385	165	330
5	210	410	175	315
6	220	430	190	340
7	230	445	205	400
8	235	455	220	430
9	240	465	235	455

Main Conventional Oven Cooking Guide

This chart is for guidance only, follow food manufacturers recommendations whenever available.

FOOD	COOKING GAS MARK	TIME	SHELF POSITION
BEEF	4-5	25-30 mins/450g + 30 mins	5
LAMB	4-5	25-30 mins/450g + 30 mins	5
PORK	4-5	35-40 mins/450g + 40 mins	5
POULTRY	4-5	25-30 mins/450g +25 mins	5
CASSEROLES	3	1.5/2 hours dependant on quantity	4 or 5
FRUIT CAKE	2	2 - 3.5 hours dependant on size	3
SMALL CAKES	5	17-25 mins	2 & 4
VICTORIA SANDWICH	4	20-30 mins	2 & 4
APPLE PIE	6	50-60 mins	1
SCONES	7	12-15 mins	1 & 3

Top Conventional Oven Cooking Guide (GT 756)

This chart is for guidance only, follow food manufacturers recommendations whenever available.

FOOD	COOKING GAS MARK	TIME	SHELF POSITION
BEEF	5-6	25-30 mins/450g + 30 mins	2
LAMB	5-6	25-30 mins/450g + 30 mins	2
PORK	5-6	35-40 mins/450g + 30 mins	2
POULTRY	5-6	25-30 mins/450g + 25 mins	2
SMALL CAKES	5	17-25 mins	1
SCONES	7	12-15 mins	1

Accuracy:- Note that times and temperatures in this book are for guidance only.

Care and Cleaning

TURN OFF COOKER AT MAIN WALL SWITCH BEFORE CLEANING

Before switching on again, ensure that all controls are in the OFF position.

Refer to instructions below for cleaning the 'Cookclean' removable side oven panels.

Glass Lid (Glass)

Clean with a cloth wrung out in soapy water. Stubborn stains can be removed with a cream, paste or liquid cleaner, or by gently rubbing with liberally soaped, very fine steel wool pads. Polish with a clean dry cloth or kitchen roll.

Glass Lid (Painted Trims)

Clean with a cloth wrung out in hot soapy water only. Polish with a clean dry cloth or kitchen roll.

DO NOT USE ABRASIVES.

Burners

The pan supports can be removed and the top burner plate can be cleaned with soapy water and rinsed with a dry cloth. Wash and rinse the gas burner caps and the pan supports with soapy water. Never wash them in a dishwasher. For the dirt and stains on the burner heads that does not wash off, use a proprietary metal surface cleaner

Vitreous Enamel Hob Surround

Clean with a cloth wrung out in soapy water. Stubborn stains can be removed with a cream, paste or liquid cleaner, or by gently rubbing with liberally soaped, very fine steel wool pads.

Control Panel

Wipe over the control panel with a damp cloth and polish with a dry cloth. Do not use oven cleaners or aerosols scouring pads or abrasive powder for cleaning the plastic knobs, as damage will occur.

How 'Cookclean' Oven Liners Work (If fitted)

The surfaces of the 'Cookclean' oven liners are treated on the mottled face with a special vitreous enamel which absorbs cooking soils at temperatures of 220°C (Gas Mk 6) or above, the special surface enables these soils to be slowly destroyed. The higher the temperature the more effective it is. In most cases normal cooking operation at this temperature will permit this cleaning operation to proceed during cooking. However if higher cooking temperatures are not used regularly it may be necessary, to prevent heavy soiling, to run the oven at a higher temperature setting of 230°C (Gas Mk 9) for a couple of hours. This may be necessary once a month or once every two or three months, depending on the type and amount of oven cooking.

'Cookclean Panels' (If fitted)

It should not normally be necessary to clean the 'Cookclean' panels in water. If the user feels it is desirable to do so, remove the rod shelf and the side panels and wash them in warm soapy water, followed by rinsing in clear water.

Do not use enzyme/biological washing powder, harsh abrasives or oven chemical cleaners of any kind.

Do not rub the surface dry as it can damage the 'Cookclean' finish. After cleaning, replace the panels immediately and run the oven at maximum setting for about 30 minutes to prevent deterioration of the enamel.

Oven & Grill compartments

Remove the grill/meat pan and grid. It is best to wash these items immediately after use to prevent stains from being burnt on when used again.

Wipe around the oven or grill compartment, removing stubborn stains with a fine soap impregnated steel wool pad. Harsh abrasives should be avoided.

Remove the rod shelf for washing at the sink. Use a fine steel wool soap pad for removing stubborn stains from the rod shelf and floor of the oven. Take care during cleaning not to damage, bend or dislodge from the supporting clips the thermostat dial which is across the back of the oven just below the roof in the oven compartment.

Doors and Handles

Wipe over with a cloth wrung out in hot soapy water and rinse with a cloth wrung out in clear water. Dry with a soft clean cloth.

Do not use scouring pads or abrasive powder which may scratch the surface.

Take care during cleaning not to damage or distort the Door Seal. Do not lift the Door Seal from the Oven Front Frame, if necessary remove the seal by carefully unhooking the corner clips.

N.B. Care must be taken that Rating Label edges are not lifted during cleaning and furthermore that the lettering is not blurred or removed. Only use oven cleaners which carry the Vitreous Enamel Development Council's Approvals symbol, and always follow the manufacturers instructions for use.

Models with removeable inner glass panels

When you wish to clean the interior glass of the oven door, use a screwdriver to remove the top and bottom washers that secures the interior glass to the door, remove the glass with care. Clean as above, but do not use house hold detergent, bleach, scouring pads or rust removers. After drying, position the gasket back into its place. Reinstall the glass panels carefully preventing sudden shocks.

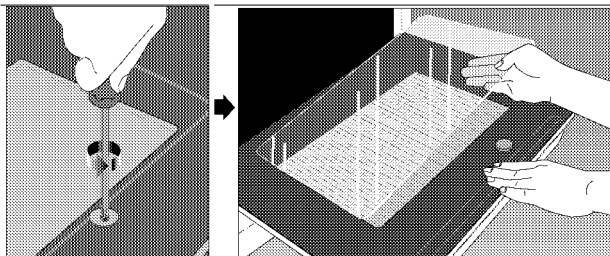

*** If low emissive glass is fitted, ensure the printed side is facing outwards.**

Replacing the Oven Lamp (GT 756)

If the oven lamp fails you can replace it yourself by following these few instructions:-

WARNING! Switch off the cooker at the mains supply before attempting to replace the oven lamp.

Remove the oven shelves. Unscrew and remove the lamp cover glass. Unscrew the lamp and replace it with a new 25W - 230V SES (300°C) lamp. These are the only lamps suitable for use in your cooker.

Replace the lamp cover glass before switching on.

NOTE:- The oven lamp is not covered by the guarantee. For a replacement call our Spares Department on (tel.0844 815 3745)

Something Wrong with your Cooker?

Before contacting your Belling approved Service Centre/Installer, check the problem guide below; there may be nothing wrong with your cooker.

Problem	Check
Slight odour or small amount of smoke when using the cooker for the first time.	This is normal and should cease after a short period.
Sinking of cakes	The following may cause cakes to sink: 1. Cooking at too high a temperature. 2. Using normal creaming method with soft margarine.
Over/Under cooking Fast/Slow cooking	Refer to the cooking times and temperatures given in the oven temperature charts, however, it may be necessary to increase or decrease temperatures by 1/2 gas mark (10°C) to suit personal taste. Do not use oven/meat pans greater than 56mm (2 1/4 ") in height. Rotate/Turn the food.
Nothing works	Is the main cooker electric wall switch turned on? Is the gas supply turned on?
Hob Burners do not work	Is the glass lid in its fully opened (Upright) position?
Ignition does not work	If all hotplate burners fail to ignite, check that there are sparks at the burners, a clicking noise should be heard. Check that the burner parts are seated correctly and that the slots in the burner body are not blocked. All burners can be lit with a match in case of ignition failure.

Customer Care Centre

In case of difficulty within the UK please call,
having the model number and serial number to hand:

Opening Hours for Customer Care Centre

Monday to Friday	8am - 8pm
Saturday	8:30am - 6pm
Sunday	10am - 4 pm

For Belling Customer Helpline please call

0844 815 3746

For Belling Service please call

0844 815 3746

For Belling Spares please call

0844 815 3745

Model No

--	--	--	--	--	--	--	--	--	--

Serial No

--	--	--	--	--	--	--	--	--	--

Glen Dimplex Home Appliances, Stones Lane,
Prescot, Merseyside L35 2XW

