

# **Gen-Eye™**

***Pipe Inspection Location System***

## **G3 Locator and Transmitter Instruction Manual**



**General** / **General Wire Spring Co.**  
**PIPE CLEANERS**  
1101 Thompson Avenue • McKees Rocks, PA 15136 USA  
800-245-6200 or 412-771-6300 • Fax: 412-771-2771  
[www.drainbrain.com](http://www.drainbrain.com) • e-mail: [info@drainbrain.com](mailto:info@drainbrain.com)



**054-092**  
Issue 2.0

---

# INTRODUCTION

Your Gen-Eye digital pipe location system is designed to give you years of trouble-free, profitable service. However, no locator is better than its operator. We therefore suggest that you read these instructions through carefully before using your machine on the job. This will enable you to operate the Gen-Eye digital pipe location system more efficiently and more profitably. Failure to follow these instructions may cause personal injury to operator or damage to equipment.

**Operator's Manual**  
**Gen-Eye Digital Pipe Location System**

Issue No.2.0/OP-5/03  
Part Number 054-092

Copyright 2003  
by The Charles Machine Works, Inc.,  
Perry, Oklahoma

Gen-Eye is a trademark of General Wire Spring Company.

U.S. Patent No. 5,065,098; 4,881,083. Other U.S. and foreign patents pending.

# SUPPORT

## SERIAL NUMBER RECORD

Record the serial numbers and date of purchase of your Gen-Eye digital pipe inspection/location system in the spaces below.

<b>Date of purchase:</b>	
<b>Locator serial number:</b>	
<b>Transmitter serial number:</b>	

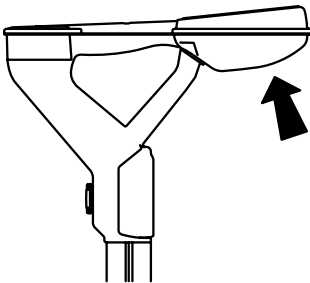

0001c.eps

**G3 Locator**

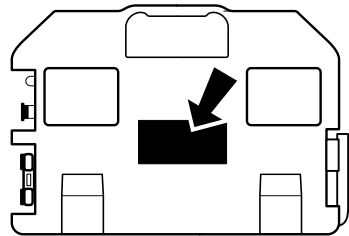

**G3 Transmitter**

## **SERVICE PROCEDURE**

Notify your dealer immediately of any equipment malfunction.

Always give model, serial number, and approximate date of purchase. This information should be recorded and placed on file by owner at time of purchase. Give detailed explanation of malfunction.

---

# CONTENTS

<b>INTRODUCTION</b> .....	<b>1</b>
<b>SUPPORT</b> .....	<b>3</b>
Serial Number Record .....	3
Service Procedure .....	4
<b>SAFETY</b> .....	<b>7</b>
Safety Alert Classifications .....	8
Safety Alerts .....	9
<b>LOCATOR</b> .....	<b>11</b>
Overview .....	11
Controls (Single Key) .....	12
Controls (Double Key) .....	14
Display .....	15
Setup .....	20
<b>TRANSMITTER</b> .....	<b>21</b>
Overview .....	21
Controls and Indicators .....	22
Setup .....	23

<b>OPERATION</b> .....	<b>25</b>
Choose Signal Type .....	25
Choose Antenna Configuration .....	27
Recognize Common Signal Problems .....	28
Camera Location .....	30
Active Location .....	34
Passive Power Line Location .....	40
<b>CARE AND ERROR CODES</b> .....	<b>45</b>
General Care .....	45
Error Codes .....	46
<b>SPECIFICATIONS</b> .....	<b>47</b>
Locator .....	47
Transmitter .....	49
<b>WARRANTY</b> .....	<b>51</b>

---

# SAFETY

Follow these guidelines before operating any jobsite equipment:

- Read and follow all safety precautions.
- Complete proper training and read operator's manual before using equipment.
- Use equipment only as directed.
- Before you dig, contact One-Call (888-258-0808) and any utility companies which do not subscribe to One-Call. Have all underground pipes and cables located and marked before sweeping area.
- Classify jobsite based on its hazards and use correct tools and machinery, safety equipment, and work methods for jobsite.
- Wear personal protective equipment.
- Check that equipment is in good condition, and test leads are clean and have no cracked insulation.
- Contact General Wire Spring Co. at 412-771-6300 if you have any question about operation, maintenance, or equipment use.





## SAFETY ALERT CLASSIFICATIONS

These classifications and the icons defined on the following pages work together to alert you to situations which could be harmful to you, jobsite bystanders or your equipment. When you see these words and icons in the book or on the machine, carefully read and follow all instructions. **YOUR SAFETY IS AT STAKE.**

Watch for the three safety alert levels: **DANGER**, **WARNING** and **CAUTION**. Learn what each level means.

 **DANGER** indicates an imminently hazardous situation which, if not avoided, will result in death or serious injury.

 **WARNING** indicates a potentially hazardous situation which, if not avoided, could result in death or serious injury.

 **CAUTION** indicates a potentially hazardous situation which, if not avoided, may result in minor or moderate injury.

Watch for two other words: **NOTICE** and **IMPORTANT**.

**NOTICE** can keep you from doing something that might damage the machine or someone's property. It can also alert you against unsafe practices.

**IMPORTANT** can help you do a better job or make your job easier in some way.

## SAFETY ALERTS

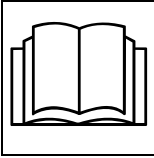

**⚠ WARNING**

Incorrect procedures could result in death, injury, or property damage. Learn to use equipment correctly.

### NOTICES:

- Electric shock or equipment damage can result if transmitter is connected to live cable. Have qualified personnel disconnect both ends of cable before working.
- Turn off transmitter when connecting or moving ground stake.
- If target depth and location are critical, confirm by hand-digging.

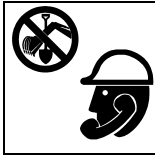

**⚠ WARNING**

Jobsite hazards could cause death or serious injury. Use correct equipment and work methods. Use and maintain proper safety equipment.



**⚠ WARNING**

Moving traffic - hazardous situation. Death or serious injury could result. Avoid moving vehicles, wear high visibility clothing, post appropriate warning signs.



# LOCATOR

## OVERVIEW

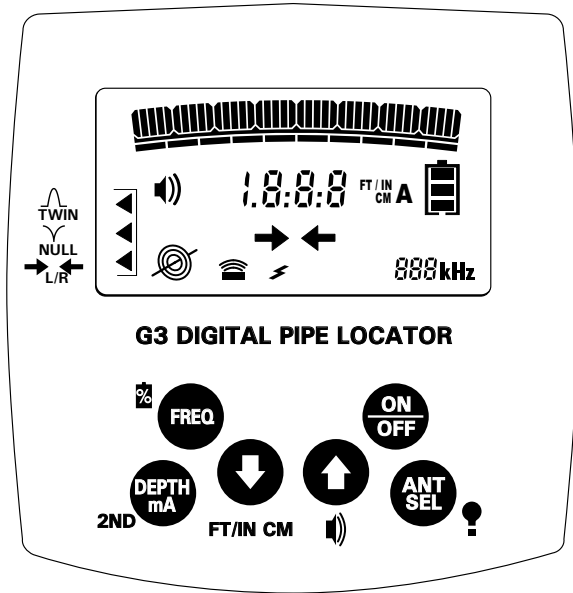

The Gen-Eye digital pipe inspection/location system is designed to locate inspection cameras as well as buried pipes and cables.

Available **active** modes include either 512 Hz or 874 Hz for use with a camera inspection system and 65 kHz for use with the Gen-Eye transmitter.

Available **passive** (power line location) modes include 50Hz or 60Hz power.

## CONTROLS (SINGLE KEY)

### ON/OFF

Turns unit on and off.

- Press once to turn on.
- Press again to turn off.

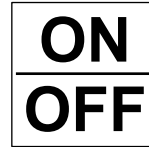

si0005c.eps

### ANT SEL

Selects twin, null, or left/right arrow antenna modes.



si0006c.eps

### Up Arrow

Press to increase manual gain incrementally.

If signal is below 20%, press once to raise gain (increase signal) to approximately 50%.

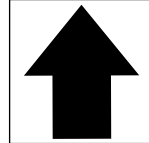

si1014a.tif

### Down Arrow

Press to decrease manual gain incrementally.

If signal is above 80%, press once to lower gain (decrease signal) to approximately 50%.

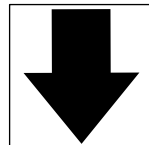

si1015a.tif

## FREQ

Selects operating frequency. Available frequencies are:

- 512 Hz (camera)
- 874 Hz (camera)
- 65 kHz (transmitter)
- 50 Hz or 60 Hz (passive line location)



c00ic144h.eps

## DEPTH

Press to estimate depth of properly located signal source.

See **OPERATION** for information on locating signals.



si0008c.eps

## CONTROLS (DOUBLE KEY)

Press and hold **DEPTH** and press the indicated button to use the functions below.

### DEPTH + ANT SEL

Turns on backlight.



si0008c.eps



si0006c.eps

### DEPTH + Up Arrow

Changes volume.



si0008c.eps

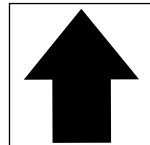

si1014a.tif

### DEPTH + Down Arrow

Changes the units of measurement in which the depth displays. Available displays are ft/in, in, cm, or m.



si0008c.eps

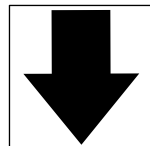

si1015a.tif

### DEPTH + FREQ

Shows percent of battery life remaining.



si0008c.eps



c00ic144h.eps

## DISPLAY

### Frequency

The locator can operate in four frequencies:

- 512 Hz (camera)
- 874 Hz (camera)
- 65 kHz (transmitter)
- 50 Hz or 60 Hz (passive line location)

The icon for the currently selected frequency is shown along the bottom of the display.

#### Camera

Allows locator to locate an inspection camera with either a 512-Hz or 874-Hz frequency.

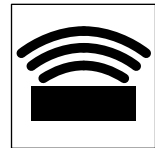

si1008a.tif

#### Transmitter

Allows locator to trace lines or pipes that have had a 65 kHz signal placed on them by a transmitter.

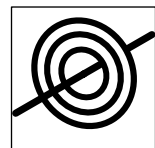

si0009c.eps

#### Power

Allows locator to trace live 50 Hz or 60 Hz power lines.

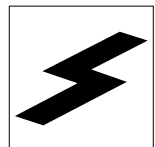

si1007a.eps

**IMPORTANT:** Current must be flowing through the line.



## Antenna

The locator has three antenna modes described below. The selected antenna mode is indicated by an arrow on the left side of the display.

### Twin Peak

Gives very sharp location. Signal strength peaks when locator is over the line being located.

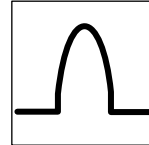

si0012c.eps

### Null

Gives precise response when locating lines in uncongested areas. Signal drops to minimum strength when locator is over the line being located. In congested areas, confirm location by using twin peak antenna.

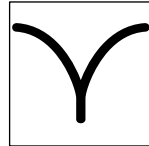

si0013c.eps

### Left/Right

Indicates position of locator relative to the line being located. Used primarily for line locate mode, but can also be used as a fore/aft indicator in camera mode.

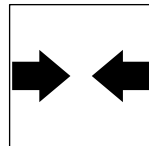

si0014c.eps

- Move locator in the direction of the arrow.
- When locator is over the line, both arrows display and two beeps sound.

## Signal Strength

Signal strength is shown by bars at top of display and in numeric display. Signal strength is also indicated by audio tone.

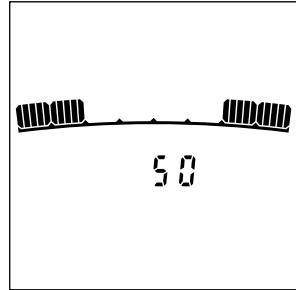

ss0004c.eps

## Gain

Gain (amount of signal amplification) is shown by bars below signal strength indicator. Gain increases to the right.

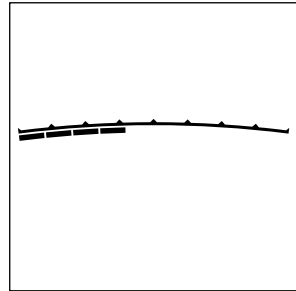

ss0007c.eps

## Depth

Estimated depth displays when **DEPTH** button is pressed.

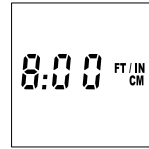

ss0008c.eps

Locator can display in four units of measurement: feet/inches, inches, centimeters, or meters. To select units, press and hold **DEPTH** and press the down arrow.

**IMPORTANT:** If four dashes appear in the display, the locator may be detecting a signal above it and cannot estimate depth. This message is usually caused by interfering signals. Too little or too much signal can also cause this indication.

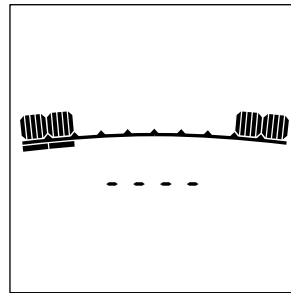

ss1082a.eps

Adjust gain and try relocating the target signal.

## Volume Level

Locator has four volume levels: off, low, medium, and high. To select volume setting, press and hold **DEPTH** and press the up arrow.

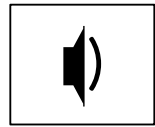

si0004h.cdr

**IMPORTANT:** Lower volume to conserve battery life.

## Locator Battery Level

Locator battery level is shown by battery icon on right side of display.

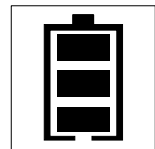

ss0009c.eps

- Three segments mean that batteries are at full power.
- One segment means that batteries are at low power.
- No segments and a flashing outline means that you should change batteries immediately.

**IMPORTANT:** To see percentage of battery life remaining, press and hold **DEPTH** and press **FREQ**.

## SETUP

### Install Batteries

Use six C-cell alkaline batteries in locator.

#### To install:

1. Unscrew battery cover.
2. Insert batteries as shown.
3. Close cover and tighten screw.
4. Check operation.

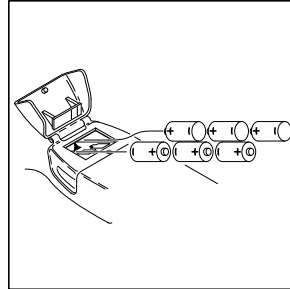

ss0028h.cdr

### Check Operation

Always check that locator is operating before leaving for jobsite and after every battery change.

#### To check operation:

1. Turn on locator.
2. Entire display will light briefly.
3. Display will show battery level and last used setting.

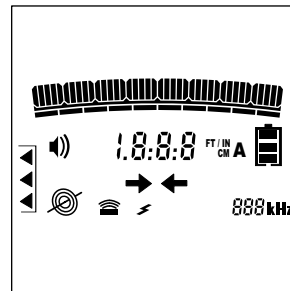

e02om002h.eps

# TRANSMITTER

## OVERVIEW

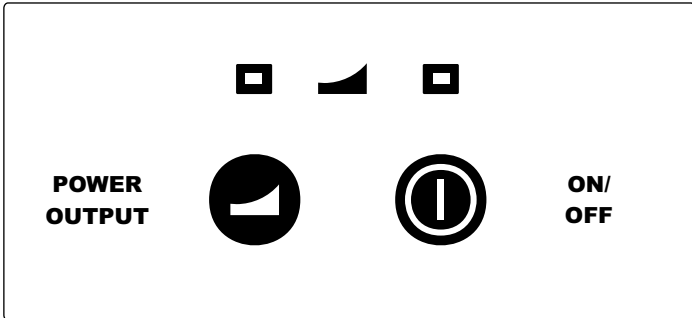

ss1130h.eps

The Gen-Eye transmitter is designed to place signals on target lines. It sends a 65-kHz frequency. It places a signal on the line through either direct connection or broadcast modes.

## CONTROLS AND INDICATORS

### ON/OFF Button

Turns unit on and off.

- Press once to turn on.
- Press again to turn off.

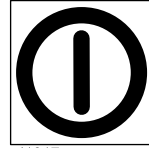

si01017a.eps

### POWER OUTPUT Button

Selects low or high power output.

- On power up, the transmitter defaults to low power output.
- Press once to change to high.
- Press again to change to low.

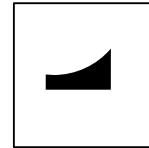

si0012h.eps

### Power Output LEDs

Display which power output is currently functioning.

- Green LED indicates low power.
- Red LED indicates high power.

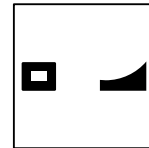

si0013h.eps

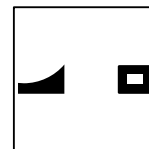

si0014h.eps

## SETUP

### Install Batteries

Use six D-cell alkaline batteries in transmitter.

#### To install:

1. Unscrew battery cover.
2. Insert batteries as shown.
3. Close and tighten battery cover.
4. Check operation.

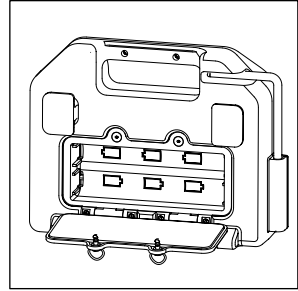

ss1135h.eps

### Check Operation

Always check that transmitter is operating before leaving for jobsite and after every battery change.

#### To check operation:

1. Turn on transmitter.
2. Transmitter will beep and green LED will light.

**NOTICE:** If both LEDs flash and transmitter beeps repeatedly, batteries are low.





# OPERATION

This section contains basic information about choosing signal type and antenna configuration, and avoiding and correcting common signal problems with two types of locating.

## CHOOSE SIGNAL TYPE

The Gen-Eye G3 locator can detect two types of signals:

- **Active signals** are placed on a target line with the transmitter and detected by the locator. An active signal from a **camera** can also be detected by the locator.
- **Passive signals** reside on the target line and are read by locator.

Read the descriptions on the next page and determine the signal type to use for your job.

## Camera Location

Camera signals allow the user to trace the camera in either metal or nonmetal pipes.

## Active Line Location

There are two ways to place active signals on a target line with a transmitter:

- **Direct connection** (preferred method) requires a connection to be made directly onto target line.
- **Broadcast** method sends current into lines near the transmitter.

## Passive Power Line Location

Some utility lines pick up signals from the environment and carry them as detectable signals. These passive signals are power signals.

## CHOOSE ANTENNA CONFIGURATION

The Gen-Eye locator has three antenna configurations:

### Twin Peak

Uses two horizontal antenna to detect signal. Response is highest at strongest signal.

### Null

Uses a vertical antenna to detect signal. Search width is narrower than single peak. Response is lowest when locator is over the line.

### Left/Right

Uses arrows to guide the operator to the camera or target line.

**IMPORTANT:** It is best to verify left/right location using twin peak antenna.

## Advantages/Disadvantages

Read the descriptions below and determine the antenna configuration that best fits your job.

Antenna	Advantages	Disadvantages
twin peak	most precise	less range
null	sharp response	easily distorted in congested areas
left/right	easy to use for most locating jobs	easily distorted in congested areas

## RECOGNIZE COMMON SIGNAL PROBLEMS

Distortions in the electromagnetic field around a camera or line can affect location and depth accuracy. Tees, bends, parallel lines, crossing lines, or large metallic objects can distort signals.

**NOTICE:** If target depth and location are critical, confirm by hand-digging or vacuum excavation.

Learn to recognize the following kinds of distortion:

### Shadows

Shadows, also called blind spots, often happen when a metallic object partially obstructs signal, or a signal from a parallel line interferes with target signal.

### False Signals

False signals describe situations where the locator indicates a line location where there is no line. False signals often happen when a line tees or bends, runs parallel to the target line, or crosses the target line.

**IMPORTANT:** Generally, the locator shows less distortion in twin peak antenna configuration.

## Secondary (Ghost) Signals

A typical camera signal pattern shows a main signal and two weaker secondary signals. Identify camera location at the main signal. Familiarity with camera signal patterns will lessen the effect of ghost signals.

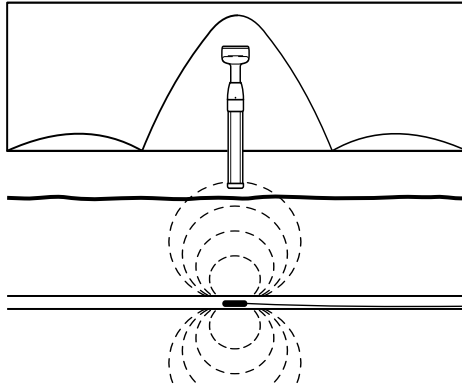

ss1025a.eps

# CAMERA LOCATION

## Command Module Overview

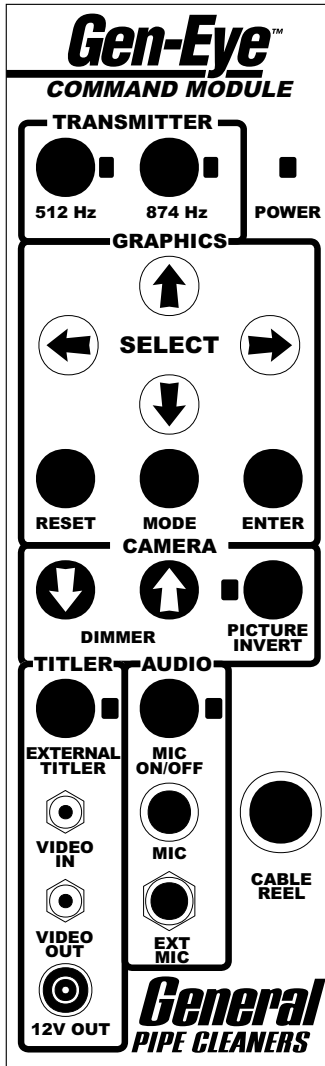

## **Set Up**

1. Turn on power switch on Gen-Eye command module.
2. Turn on locator and check that the battery indicator shows at least one bar. Replace batteries if needed.
3. Press the **FREQ** button until locator frequency matches transmitter frequency.
4. Press the **ANT SEL** button until indicator points to **TWIN**, indicating twin peak antenna.
5. Press the up arrow so that the gain bar is at the maximum setting.



## Locate

1. Hold the locator so that **the handle is at a 90° angle to the camera head**, as shown.
2. Walk in a small arc around the drain opening.
3. Identify location of camera by finding the spot with the strongest signal response.

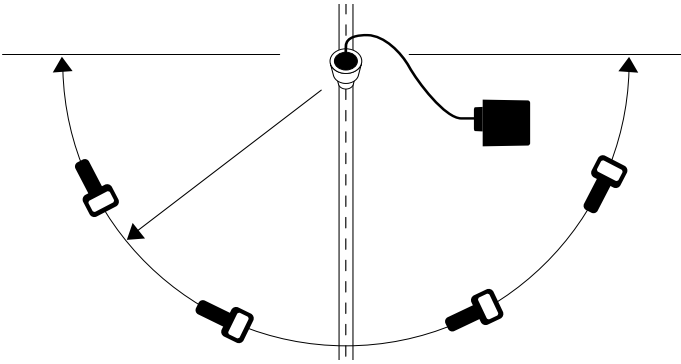

e02om004h.eps

**IMPORTANT:** The camera must be stationary to locate a precise signal.

4. Sweep the locator along the camera path until you obtain a peak reading.
5. If the display indicates a maximum signal of 100, reduce gain. Press the down arrow to keep gain at approximately 50-70%.
6. Repeat steps 4-5 to narrow your search area.

**IMPORTANT:** A ghost signal may appear before and behind the the peak reading. Press the down arrow to lower gain until you receive only one signal. For more information, see "Secondary (Ghost) Signals" in **OPERATION**.

7. When you receive only one signal in a 1 ft<sup>2</sup> (0.1 m<sup>2</sup>) area, you've located the camera. Mark the spot.
8. Set the locator on the ground and press the DEPTH button to estimate depth.

## Operating Tip

The closer the camera is to the drain opening, the easier it is to locate.

- Push the camera 5-10' (1.5-3.0 m) into the pipe and do the first locate. Mark the spot.
- Push the camera another 5-10' (1.5-3.0 m) and repeat until the entire pipe is traced and marked.

## ACTIVE LOCATION

### Setup

Follow setup procedures for the type of locating you will be doing: direct connection or broadcast induction.

#### Direct Connection

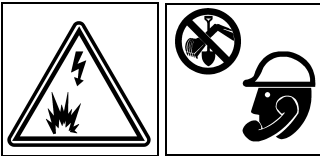

**⚠ WARNING** Jobsite hazards could cause death or serious injury. Use correct equipment and work methods. Use and maintain proper safety equipment.

**NOTICE:** Electric shock or equipment damage can result if transmitter is connected to live cable. Contact qualified utility personnel and follow all local standards and restrictions for disconnecting and grounding lines.

To set up transmitter for direct connection:

1. Drive ground stake.
2. Plug cable into transmitter.
3. Hook black lead to ground stake.
4. Hook red lead to target line.
5. Turn on transmitter.
6. Check battery level.

**NOTICE:** Turn off transmitter when connecting or moving ground stake.

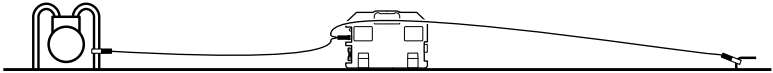

ss0014c.eps

## Broadcast Induction

To set up transmitter for broadcast induction:

1. Remove cable, stake, clamp and any other metal objects from transmitter.
2. Place transmitter over line.
3. Turn on transmitter.
4. Check battery level.

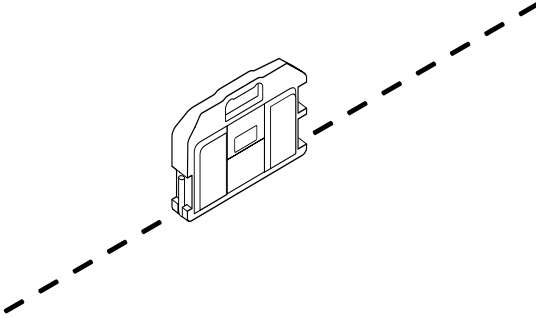

0017c.eps

## Technique

**IMPORTANT:** Follow steps 1-3 for all types of active location. For reference, the illustration below shows direct connection method. If using broadcast induction, ensure that transmitter is in line with and above suspected line, as shown on previous page.

1. Walk in an arc approximately 25' (7.5 m) around transmitter.
2. Hold the locator so that **the handle points toward the transmitter**, as shown.
3. Identify location of line by finding the spot with the strongest signal response.

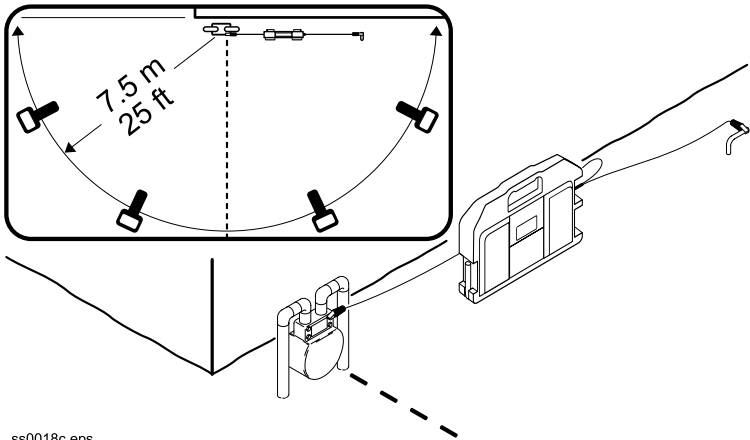

ss0018c.eps

4. Rotate the locator to determine which direction the line runs.

**IMPORTANT:** Locator indicates the strongest signal when the handle lines up with the target line.

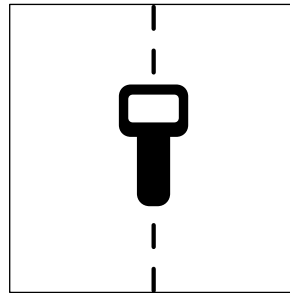

ss1080a.eps

5. When the line has been located, set locator base on the ground and press **DEPTH** button .
6. Continue to trace the line and take depth estimates every few paces.
7. Retrace the line and mark with appropriate flags or paint.

## Special Situations

<b>Situation</b>	<b>What to try</b>
Signal is lost.	Walk in a circle to detect a tee or bend in the line.
Signal varies from low to high and is unstable.	Mark as a hand-dig area.
You are near a power line and are receiving interference such as unstable depth readings, blank display, etc.	Sweep the area in 50 Hz or 60 Hz power mode. If locator gives a strong signal response, a power line is interfering with transmitter signal.
Locator does not function properly.	Locator gain could be set too high. Lower gain to locate the line.
Target line has connections to other lines.	Disconnect target line from other lines or use induction clamp to focus signal on target line.
Signal is transferring to other lines.	<ul style="list-style-type: none"><li>• Lower the power level.</li><li>• Use direct connection, if possible.</li><li>• Move the ground stake away from the target line and away from other buried lines.</li><li>• Apply signal at the point where the target line is farthest from the other lines.</li></ul>
Four dashes appear on the display and signal strength and gain bars flash.	Transmitter power level is set too high and/or line is too shallow for depth estimate. Select lowest usable transmitter power level or raise locator high enough to return display to normal operation.



# PASSIVE POWER LINE LOCATION

## Setup

To set up for passive power line location, turn on locator and check battery level at startup.

**NOTICE:** Lines with no A/C current flowing through them are hard to detect and dangerous because they still have voltage. To locate, turn on an appliance to cause current flow or use active search method.

## Technique

### Survey the Site

Make a visual check of the site for signs of buried lines such as:

- recent trenching
- buried line markers
- overhead lines that run down pole and underground
- gas meters
- valve sights
- drains or manhole covers

### Sweep the Site

Search the site by walking a grid pattern while holding locator close to the ground.

**IMPORTANT:** Keep the locator vertical.

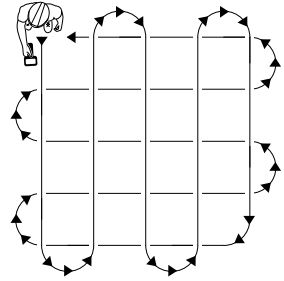

ss1076a.eps

### Focus the Signal

Move the locator over the detected signal to find the strongest signal response. If using a peak antenna mode, rotate the locator until the signal is strongest. Strongest signal indicates line direction.

### Trace the Line

Walk along the suspected path while moving the locator back and forth across the area.

**IMPORTANT:** Keep locator handle parallel to the suspected line path.

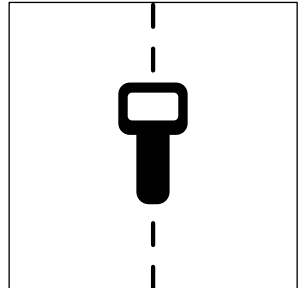

ss1080a.eps

**Mark the Line**

Sweep, focus, and trace all detected signals in the area. Mark line paths with colored paint or flags. See the chart below for standard color markings for line locations.

<b>Utility</b>	<b>Color</b>	<b>Marking Symbol</b>
electric	red	-E-
gas/oil	yellow	-G-
communications	orange	-TEL- or -TV-
water	blue	-W-
sewer	green	-S-

## Special Situations

Situation	What to try
Signal is lost.	Walk in a circle to detect a tee or bend in the line.
Signal varies from low to high and is unstable.	Mark as a hand-dig area.
Locator does not function properly.	Locator gain could be set too high or low. Lower or raise gain to locate the line.
Four dashes appear on the display and signal strength and gain bars flash.	Transmitter power level is set too high and/or line is too shallow for depth estimate. Select lowest usable transmitter power level or lift locator high enough to return display to normal operation.
Four dashes appear on the display when <b>DEPTH</b> button is pressed.	The locator is detecting a signal above it and cannot estimate depth. This message is usually caused by interfering signals. Try relocating target signal.



# CARE AND ERROR CODES

Under normal operating conditions, locator needs only minor maintenance. Following these care instructions can ensure longer equipment life.

## GENERAL CARE

- Do not drop the equipment.
- Do not expose the equipment to high heat (such as in the rear window of a car).
- Clean equipment with a damp cloth and mild soap. Never use scouring powder.
- Do not immerse in any liquid.
- Inspect housing daily for cracks or other damage. If housing is damaged, contact your dealer for replacement.

## ERROR CODES

If four dashes appear in the display when pressing the **DEPTH** button, the locator is detecting a signal above it and cannot estimate depth. This message is usually caused by interfering signals. Try relocating target signal.

If four dashes appear on the display and signal strength and gain bars flash, transmitter power level is set too high and/or line is too shallow for depth estimate. Select lowest usable transmitter power level or lift locator high enough to return display to normal operation.

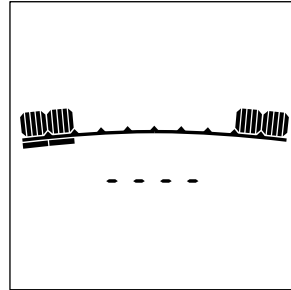

ss1082a.eps

# SPECIFICATIONS

## LOCATOR

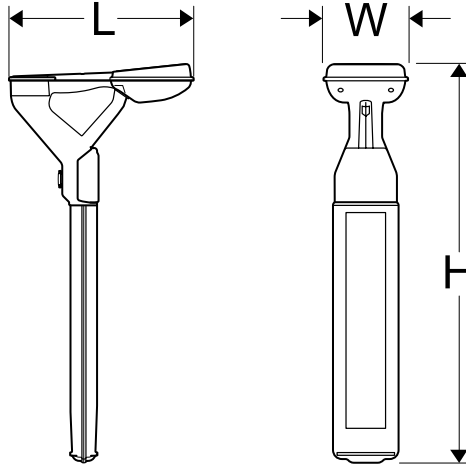

ss0003c.eps

Dimensions	U.S.	Metric
Length	12.8 in	32.5 cm
Width	5.9 in	14.5 cm
Height	27.8 in	70.5 cm
Operating weight	4.5 lb	2 kg



Operation		U.S.	Metric
Operating temperature range		-4°F to 122°F	-20°C to 50°C
Antenna configurations		single peak, twin peak, null, left/right (line only)	
Audio output		speaker	
Operating modes			
	Active line: 512 Hz, 65 kHz, 874 Hz		
	Camera: 512 Hz, 874 Hz		
	Passive line: 50 Hz or 60 Hz		
Locating ranges		15 ft	4.6 m
Maximum depth ranges*			
	Camera $\pm 5\%$	.5 - 10 ft	.15 - 3 m
	Camera $\pm 10\%$	10 ft and deeper	3 m and deeper
	Passive line $\pm 10\%$	.5 - 10 ft	.15 - 3 m
	Active line $\pm 3\%$	.2 - 5 ft	.06 - 1.5 m
	Active line $\pm 5\%$	5 - 10 ft	1.5 - 3 m
	Active line $\pm 10\%$	10 ft and deeper	3 m and deeper
LCD backlight		LED (green)	
Batteries			
Batteries		6 C-cell alkaline	
Battery life (continuous use at 70°F [21°C])		approximately 50 hours	
Battery saver		unit shuts off after 5 minutes of inactivity	

\*Locators are calibrated to these tolerances under ideal test field conditions. Actual operating field conditions may have signal distortions or may contain noise sources which result in depth estimate accuracy that is less than specified.

# TRANSMITTER

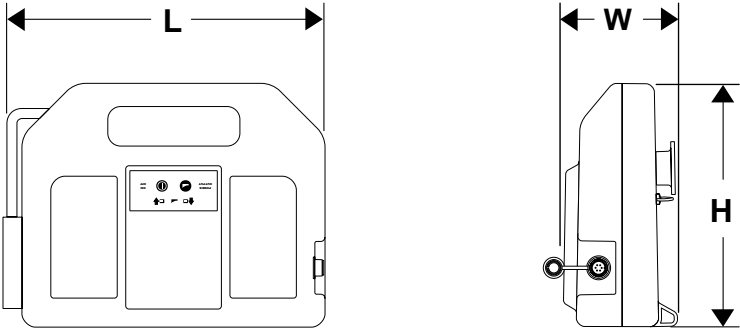

ss1128h.eps

<b>Dimensions</b>	<b>U.S.</b>	<b>Metric</b>
Length	12.25 in	311 mm
Width	4.5 in	114 mm
Height	9.25 in	235 mm
Operating weight	5.0 lb	2.3 kg
<b>Operation</b>	<b>U.S.</b>	<b>Metric</b>
Operating temperature range	-4°F to 122°F	-20°C to 50°C
Maximum power output	1 watt	1 watt
Operating frequency: 65 kHz		
<b>Batteries</b>		
Batteries	6 D-cell alkaline	
Battery life (continuous use at low power level)	approximately 150 hours	



---

# WARRANTY

## Gen-Eye Location System Limited Product Warranty Policy

### Warranty Periods

#### New Product

A 24-month period starts on the date of delivery to the end user:

- Gen-Eye transmitter
- Gen-Eye locator

A three-month period starts on the date of delivery to the end user:

- Accessories: cables, clamps

#### Service and Repair

A 90-day warranty on **labor** starts on the date the unit is repaired, and a 90-day warranty on **parts** starts on the date the unit is repaired for all products.

### Details and Exclusions

- The warranty includes only General Wire Spring Co. products and accessories that are manufactured and distributed by General Wire Spring Co. The warranty compensates on defects in material or workmanship.
- Defects will be determined through inspection by General Wire Spring Co. or authorized repair centers. Original purchaser must make the defective item available for inspection within 30 days of the date the part fails.
- The warranty is limited to replacement of the defective part. The replacement part may be new or remanufactured. Repair and removal of defective part and installation will be at no charge when product or item is delivered to General Wire Spring Co. The product or item will be returned at no charge for return freight.
- The warranty periods do not represent the useful life of General Wire Spring Co. products and accessories.

- This limited warranty applies to the original purchaser only. Some states or jurisdictions do not allow exclusion or limitation of incidental or consequential damages, so above limitation may not apply. This limited warranty gives original purchaser specific rights that vary from state to state or jurisdiction to jurisdiction.
- The General Wire Spring Co. Equipment Warranty Form must be completed for each serial numbered product and submitted to General Wire Spring Co. The information on the form is used to establish the warranty period start date.
- When the General Wire Spring Co. Equipment Warranty Form is not processed and received by General Wire Spring Co., the factory shipping date is used to establish the warranty period start date.
- Product inspection and estimates may require that the unit be disassembled and tested.
- Out-of-warranty inspection costs include labor accrued at the full labor rate plus return freight.
- Approved out-of-warranty repair costs include parts, labor accrued at full labor rate, plus return freight.