

Users Guide & Installation Handbook



Belling BI 90 MF

belling[®]

think of everything

IMPORTANT NOTICE

Please note the cooling fan fitted to this appliance is an integral part of its safety and functionality.

When the appliance is installed care must be taken that the cooling fans performance is not impeded by any objects coming into contact with it. (Installation pipes, leads etc)

Care must also be taken that there is sufficient air flow at the rear of the appliance for the cooling fan to run at its optimum efficiency. (Particularly Built In appliances) See clearance dimensions in the installation section of the booklet.

During use the Appliance must never be disconnected from the Mains supply as this will seriously affect the safety and performance of the appliance, particularly in relation to surface temperatures becoming hot and gas operated parts not working efficiently.

The cooling fan is designed to run on after the control knob has been switched off to keep the front of the appliance and the controls cool until the appliance has naturally cooled itself.

CONTENTS

User's Section	2 - 19
Introduction	2
Functions	4
Be Safe - Not Sorry	5
Using the Grills	6
Grilling in the top oven	7
Grilling in the main oven	7
Using the Top Oven	8
Using the Main Oven	9
<i>Oven cooking</i>	10
<i>Conventional Oven</i>	11
<i>Top Heat Only</i>	11
<i>Base Heat Only</i>	11
<i>Fan Oven</i>	11
<i>Fan & Base Heat Only</i>	11
<i>Intensive Bake</i>	11
<i>Defrosting and cooling</i>	12
<i>Slow cooking</i>	12
Programmer / Clock	13
Cleaning	19
Installation Instructions	21 - 23
Step 1: Prepare installation	21 & 22
Step 2: Connect to electricity supply	23
Step 3: Secure appliance to cabinetry	23
Technical Data	24
Customer Care	Back Page

INTRODUCTION

Thank you for choosing a British built appliance by Belling.

We hope the following information will help you to quickly familiarise yourself with the features of the appliance, and to use it successfully and safely.

Our policy is one of constant development and improvement. Strict accuracy of illustrations and specifications is not guaranteed. Modification to design and materials may be necessary subsequent to publication.

Please read the instructions in this handbook before using or installing this appliance.

Your 1st year guarantee

To fulfil the conditions of your guarantee, this appliance must be correctly installed and operated, in accordance with these instructions, and only be used for normal domestic purposes.

Please note that the guarantee, and Service availability, only apply to the UK and Republic of Ireland.

Before using the appliance for the first time, remove any protective polythene film and wash the oven shelves and furniture in hot soapy water to remove their protective covering of oil. Even so, when you first turn on the oven or grill you may notice a smell and some smoke.

Condensation

When hot and cold air meet, condensation forms. The outer door is air cooled and the inner door gets hot, so some condensation might form; this is normal and will disappear within 10 - 15 minutes.

Electrical connection

Please refer to installation instructions for electrical connection.

In your own interest, and that of safety, make sure that the installation is carried out by a competent person.

Disconnection of electric appliances should always be carried out by a competent person.

Warning: This appliance must be earthed.

In the event of a power cut

1. Switch off the electricity supply to the appliance at the cooker control unit.
2. When the power returns, see the 'Programmer / Clock' section to 'Set the time of day'.

INTRODUCTION

To replace an oven light bulb

WARNING - switch off the electricity supply to the appliance at the socket, to avoid the risk of electric shock.

Wait until the oven is cool, then remove the oven shelves.

The oven light is at the rear of the oven cavity.

Unscrew the lens cover (turn anticlockwise). Unscrew the bulb and replace. Replace lens cover.

Please note that the oven light bulb is not covered by guarantee.

Environmental Protection

We are committed to protecting the environment and operate an Environmental Management System which complies with BS EN ISO 14001:1996.

Disposal of packaging

- All our packaging materials are recyclable and environmentally friendly.
- Please help us to protect our environment by disposing of all packaging in an environmentally friendly manner.
- Please contact your local authority for the nearest recycling centre.

Caution: Packaging materials can pose a risk of suffocation - keep away from children.

The appliance is designed to fit into

a standard 600mm wide housing unit with a minimum internal height of 880mm.

Cooling fan

The cooling fan helps to keep the exterior cool during normal use. When an element is operated, you should heat the cooling fan switch on automatically and be able to feel air evacuating from the appliance vents just below the fascia.

The cooling fan will continue to operate for approximately 10 minutes after turning off the elements. This is normal.













If there is no such indication that the fan is operating, the appliance will require servicing. DO NOT USE THE APPLIANCE UNTIL IT HAS BEEN SERVICED. Switch the appliance off at the mains and contact Customer Support.

Glass panels

To meet the relevant Standards of Domestic cooking appliances, all the glass panels on this appliance are toughened to meet the fragmentation requirements of BS3193. This ensures that, in the unlikely event that a panel breaks, it does so into small fragments to minimise the risk of injury.

Please take care when handling, using or cleaning all glass panels as any damage to the surfaces or edges may result in the glass breaking without warning or apparent cause at a later date. Should any glass panel be damaged, we strongly recommend

FUNCTIONS

Symbol	Function / Feature	Top Oven	Main Oven
	Conventional Grill	page 7	page 7
	Economy Grill	page 7	-
	Fanned Grill	-	page 7
	Conventional Oven	page 8	page 11
	Top Heat Only	page 8	page 11
	Base Heat Only	page 8	page 11
	Fanned Oven	-	page 11
	Fan and Base Heat Only	-	page 11
	Intensive Bake	-	page 11
	Defrosting and Cooling	-	page 12
	Oven Temperature Control	✓	✓
	Oven Selector Control	-	✓

BE SAFE - NOT SORRY

When you are cooking, keep children away from the vicinity of appliance.

This product is designed as a domestic cooking appliance for the preparation and cooking of domestic food products, and should not be used for any other purpose.

- Remove all packaging from the appliance before using for the first time.
- Make sure you read and understand the instructions before using the appliance.
- Keep electrical leads short so they do not drape over the appliance or the edge of the worktop.
- Keep all flammable materials (such as curtains, furnishings & clothing) away from the appliance.
- Parts of the appliance may be hot during or immediately after use. Care should be taken to avoid touching heating elements inside the oven. Allow sufficient time for the appliance to cool after switching off.
- When opening the appliance door, take care to avoid skin contact with any steam which may escape from the cooking.
- Do not use aluminium foil to cover the grill pan, or put items wrapped in foil under the grill, as this creates a fire hazard. The high reflectivity can also damage the element.

- Do not use the oven with the door inner glass panel removed.
- Do not drape tea towels over the flue vents or doors, as this creates a fire hazard.
- Use oven gloves when removing hot food / dishes from the oven or grill. The oven / grill and utensils will be very hot when in use.
- Do not use foil on oven shelves, or allow it to block the oven flue, as this creates a fire hazard, and prevents heat circulation.
- When cooking heavy items - eg; turkeys - do not pull the oven shelf out with the item still on the shelf.
- *Drop-down doors:* Do not place items on the door when open.
- Switch off the electricity supply before replacing the oven light bulb, to avoid the possibility of electric shock.
- Never use the appliance for heating a room.

All installation, servicing and maintenance work should be carried out by a competent person who will comply with current Regulations, Standards and Requirements.

Warning: This appliance must be earthed.

When you have finished cooking check that all controls are in the off position.

USING THE GRILLS

Caution: Accessible parts may be hot when the grill is used, young children should be kept away.

Using the grills

The 900 has a grill in both oven cavities.

The top oven grill is a fully variable dual grill.

The main oven features fixed rate grilling - a single element conventional grill, and a fanned grill function.

Follow the instructions given on the next page when operating these grills.

Preheating

For best results, preheat the grill for 3 - 5 minutes.

Aluminium foil

Using aluminium foil to cover the grill pan, or putting items wrapped in foil under the grill can create a fire hazard, and the high reflectivity can damage the grill element.

Detachable grill pan handle

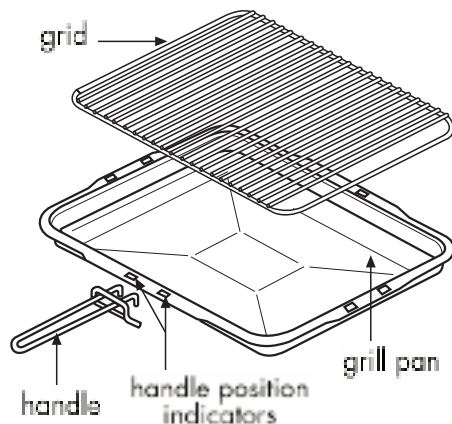

Place the handle over the edge of the grill pan, at the narrow side edges. Slide the handle to the centre, and locate between the handle position indicators.

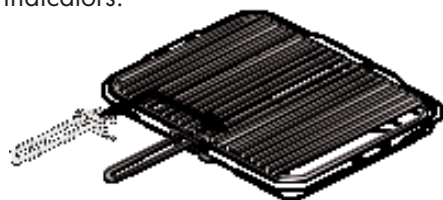

The handle should be removed from the pan during grilling, to prevent overheating.

The handle is designed for removing / inserting the grill pan under the grill when grilling.

If cleaning the grill pan when it is hot, use oven gloves to move it. *Do not* use the handle to pour hot fats from the grill pan.

Food for grilling should be positioned centrally on the trivet.



USING THE GRILLS

Grilling in the top oven

The top oven grill is a fully variable dual grill.

To switch on the grill

Important: The top oven / grill door must be kept open when the top oven grill is used - either fully open or using the door stop position - open the door about 75mm and it will hold open. If the grill door is closed whilst the grill is in use, it will cause the grill door to become hot.

Turn the oven control knob either clockwise to use the  full grill settings, or clockwise to the  economy grill settings. Then select 1 - 8 on the grill control.

The economy grill settings only use the inner element of the grill.

To switch off, return the control knob to the "●" off position.

Grilling in the main oven

The main oven grill & fanned grill are fixed settings using the inner element only.

Make sure that the programmer is set to manual before grilling.

Conventional grill

The door must be open when the grill is used for conventional grilling - either fully open or using the door stop position - open the door about 75mm and it will hold open.

If the grill door is closed while the grill is in use, the grill will cycle on and off at a high temperature, causing the door to become hot.

- (i) Turn the selector control knob to the conventional grill setting.
- (ii) Turn the oven temperature control knob to the full on setting.

Fanned grill

The door must be closed when the fanned grill is used.

When opening the door, take care to avoid skin contact with any steam which may escape from the cooking.

- (i) Turn the selector control knob to the fan grill  setting.
- (ii) Turn the oven temperature control knob to the desired temperature-setting.

When the fanned grill is selected, only the inner element will come on.

USING THE TOP OVEN

Caution: Accessible parts may be hot when the top oven is used, young children should be kept away.

The top oven is a conventional oven.

To switch on the top oven

Turn the top oven control knob to the desired temperature setting.

The red thermostat indicator will come on until the selected temperature is reached and then go off; it will turn on and off periodically as the thermostat operates to maintain the selected temperature.

To switch off, return the control to the "●" off position.

Top heat only

Turn the top oven control knob past the oven temperature markings, until the top heat symbol is in the window as shown below.

Important notes

- **Important:** Never put items directly on the base of the oven or cover the oven base with foil, as this may cause the element to overheat.

USING THE MAIN OVEN

Caution: Accessible parts may be hot when the ovens are used, young children should be kept away.

The main oven is a multi-function oven, and may be used as a conventional oven or a fanned oven. It may also be used as a grill, or with one of the other oven functions.

Manual operation

The programmer must be set to manual operation before the main oven or grill functions can be used. If **A** (Auto) is on the programmer display, return the oven to manual operation by pressing the two end buttons.

To turn on the main oven

Step 1 - Select the function

Turn the selector control knob in either direction, until the function you require appears in the window.

Step 2 - Set the main oven control

If you have selected an oven cooking function, then simply turn the main oven temperature control knob clockwise to the required temperature - this brings on the neon indicator light, which will stay on until the oven reaches the required temperature. *To switch off* the main oven, return the control knob to the "I" off position.

Automatic operation

See 'Programmer / Clock' section.

USING THE MAIN OVEN

Using the main oven

Caution: Accessible parts may be hot when the appliance is in use - keep children away from the vicinity of the oven.

Never put items directly on the base of the oven or cover the oven base with foil, as this can cause the base element to overheat.

Manual operation

Set the programmer to manual operation. See 'Programmer / Clock' section.

Turn the selector control knob to the symbol for the desired oven function.

Turn the main oven temperature control knob to the desired temperature.

The red thermostat indicator neon will come on and off until the selected temperature is reached and then go off; it will turn on and off periodically as the thermostat operates to maintain the selected temperature.

To switch off the main oven, return the main oven control knob to the "I" off position.

Automatic operation

See 'Programmer / Clock section.

Preheating

Always use the fan oven setting for preheating to save time and electricity. After the oven has been preheated on the fan oven setting, turn the selector control knob to the oven setting you require.

The oven must be preheated when cooking frozen or chilled food, and we recommend preheating for yeast mixtures, batters, soufflés and whisked sponges, otherwise preheating is not necessary as a fan oven warms up quickly.

Preheat the oven until the indicator neon switches off for the first time; this will take between 5 - 15 minutes, depending on the temperature selected.

To help the air circulate freely

- Position the shelves evenly within the oven and maintain a clearance from the oven roof and base.
- If more than one cooking dish or baking tray is to be used on a shelf, leave a gap of at least 25mm between the items themselves and the oven interior.
- Allow enough space between shelves for food that will rise during cooking.
- Do not place items on the oven base as this will prevent air from circulating freely.

USING THE MAIN OVEN

Main oven functions

Conventional oven

- (i) Turn the selector control knob to the conventional oven symbol.
- (ii) Turn the main oven control knob to the required temperature.

The temperature you select corresponds to the temperature in the middle of the oven.

The top heat comes from the outer element of the grill, and the base heat is under the oven base.

Top heat only

- (i) Turn the selector control knob to the top heat symbol.
- (ii) Turn the main oven control to the required temperature.

Base heat only

- (i) Turn the selector control knob to the base heat symbol.
- (ii) Turn the main oven control knob to the required temperature.

Fan oven

- (i) Turn the selector control knob to the fan oven symbol.
- (ii) Turn the main oven control knob to the required temperature.

The fan oven comes on when the oven is switched on and circulates the air around the oven to give a fairly even temperature throughout the oven.

Fan and base heat only

- (i) Turn the selector control to the fan and base heat symbol.
- (ii) Turn the main control to the required temperature.

Intensive bake

- (i) Turn the selector control to the intensive bake symbol.
- (ii) Turn the main oven control to the required temperature.

USING THE MAIN OVEN

Defrosting and cooling

- (i) Turn the selector control knob to defrost .
- (ii) Turn the oven control to the light symbol .

To **defrost** frozen foods, place food in the centre of the oven and close the door.

To **cool** foods after cooking prior to refrigeration or freezing, place food in the centre of the oven with the door open.

Be safe

- Do not defrost stuffed poultry using this method.
- Do not defrost larger joints of meat or poultry over 2kg / 4lb using this method.
- Never place uncooked food which is to be defrosted next to cooked food which is to be cooled, as this can lead to cross contamination.

Please refer to the *Cooking Guide* for more information on using the Defrost function.

Slow cooking

Turn the selector control to either conventional oven or fanned oven.

Do not try to slow cook using any of the other oven functions.

For roasting joints of meat or poultry and for pot roasts, preheat the oven to 190°C - 200°C and cook for 30 minutes, then adjust the oven temperature control to 110 - 120°C for the remainder of the cooking time.

- Always use the top half of the oven when slow cooking with the conventional oven function.
- Slow cooking times will be about *three times* as long as conventional cooking times.
- Make sure that frozen foods are thoroughly *thawed* before cooking.
- Do not slow cook joints of meat or poultry weighing more than 2¼kg / 4½lb. Always use the top half of the oven for slow cooking.

Programmer / Clock

Automatic cooking is only available in the main oven.

The programmer buttons

∇ down - reduce

▲ up - increase

The 'function' button in the centre is used for setting the minute minder and setting up the automatic cooking. See below for details.

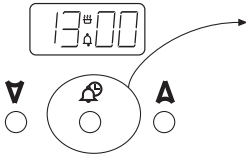

Symbols on the LED display.

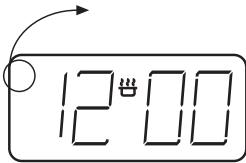

This 'A' symbol appears when either a semi, or fully automatic program is selected. This symbol will flash while a program is being set. Once a program is set the symbol will light up, and remain lit until the alarm sounds, or the program is cancelled

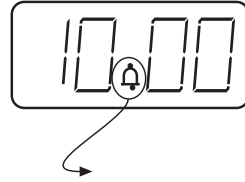

This Bell symbol appears when the Minute Minder function has been selected. While the Minute Minder is being set, the Bell symbol flashes. Once the length of time is set, the Bell symbol remains lit until the time runs down, or the function is cancelled.



This message and 'A' symbol appear when you are asked to set the length of time you require the oven to cook automatically for. Using the Up and Down buttons adjusts this accordingly.

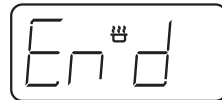

This message and 'A' symbol appear when you are asked to enter in an end time, or when you would like the oven to switch itself off.

Programmer / Clock

To set the time of day

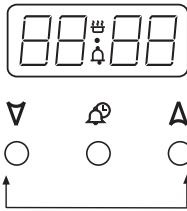

- ◆ Press the Up and Down buttons together for a few seconds, and release.
- ◆ The '●' in between the numbers on the LED Display will begin to flash.
- ◆ While the '●' is flashing it is possible to adjust the time using the Up and Down buttons. Once the time has been set, allow approximately 30 seconds before using any of the other timer functions. This ensures that the time will remain correct.

To select an alarm tone

There are three tones to chose from.

- ◆ Press and hold the *down* button to listen to the first tone.
- ◆ Release the *down* button and press it again to listen to the second tone etc.
- ◆ Releasing the *down* button after the tone has sounded will automatically select that tone

Setting the minute minder

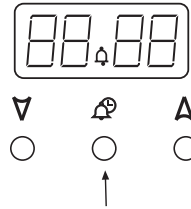

- ◆ To set the Minute Minder, press the Function button once. The bell symbol will appear and start flashing. The flashing only lasts for 5 seconds so the time must be set within this time frame.
- ◆ Use the Up and Down button to set the length of time required. Once this has been done, the Minute Minder is set.
- ◆ When the desired length of time has counted down the alarm will sound.
- ◆ To cancel the tone, press any of the buttons.
- ◆ To cancel the Minute Minder at any time, press the function button and then press the Up and Down buttons together.

Programmer / Clock

Semi-automatic cooking

There are two types of semi automatic cooking available on this appliance.

The oven must be switched on, and in use to use either of these functions successfully.

The Duration method allows you to set the oven for a specific length of time. If a dish needed 2 hours to cook, then it would be possible for you to set the oven to turn off 2 hours later. This allows you to be sure that your food will be cooked for a set length of time and no longer.

The End Time method allows you to enter a specific time when you would like the oven to switch off. If you wish to leave the oven unattended, then it offers peace of mind that the oven will have turned itself off at the set time.

To cancel the semi automatic programs, press both the Plus and Minus buttons together. This can be done at any time during the cooking process. Then if necessary, re program.

For the instructions on how to use both of these functions, please see the following page.

Fully automatic cooking

This function incorporates both a duration and an end time and is meant to be used when you wish to delay the start time.

We recommend that the first few times this function is used you are in the house, this will familiarise you with your oven and prevents food from being over cooked or under cooked.

Care must be taken when selecting foods for this function, it is not recommended for certain food items which may spoil, or are sensitive to being left.

It is also advisable to set the end time to be as close to your return as possible to prevent food being left standing.

Programmer / Clock

Semi-automatic cooking

The Duration method

- ◆ Press the Function button twice, **(1)** which will skip past the Minute Minder.
- ◆ The LED display will flash the word 'dur', **(2)** and the 'A' will flash on the left hand side of the display.
- ◆ Use the Up and Down buttons to set the length of time you want to cook for. **(3)** This must be done within 5 seconds or the time of day will show again.

Once this is done the oven will automatically switch off once the time has elapsed, and the alarm will sound. To switch off the alarm, press any button. To view any remaining time press the function button twice

The End Time method

- ◆ Press the Function button three times, which will skip past the Minute Minder and the Duration programmer. **(4)**
- ◆ The LED display will flash the word 'End' and the 'A' will flash on the left hand side of the display. **(5)**
- ◆ Use the Up and Down buttons to select the time the oven is required to turn off. **(6)**

Once this is done the oven will turn itself off at the time you have selected. To switch off the alarm, press any button.

1. The Duration method

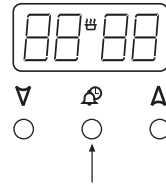

2.



3.

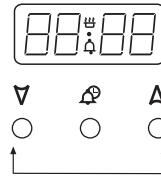

4. The End Time method

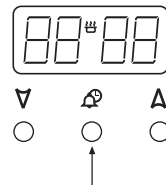

5.



6.

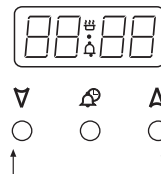

Programmer / Clock

Fully automatic cooking (example)

This programming method is best suited for when a delayed start time is required. Unlike the semi automatic methods this requires both the duration and the end time to be entered. The timer will work out the start time and begin cooking.

◆ Press the function button twice to select the length of time your food will need. **(7)**

◆ The 'A' on the left hand side will flash and the 'dur' message will flash up. **(8)**

◆ Using the Up and Down buttons set the time you require within 5 seconds of the 'dur' message. **(9)**

◆ Press the function button three times until the 'A' flashes again and the 'End' messages appears. **(10) & (11)**

◆ Using the Up and Down buttons, set the time you would like the oven to switch off. **(12)**

◆ Set the temperature of the oven and place the food inside.

While the automatic function is running, the 'A' will appear statically on the display, with the time.

Try to keep the end time as close to when you expect to return, this will prevent cooked food from being left standing in a warm oven.

The timer will calculate the appropriate start time.

To switch off the alarm, press any button

7

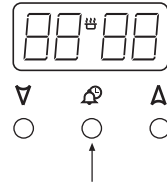

8



9

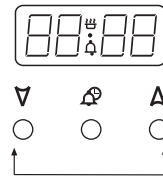

10

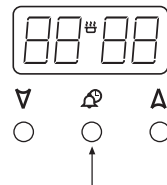

11



12

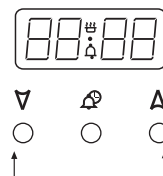

Automatic cooking - hints

Automatic cooking

These notes below are to help you with using the automatic cooking facility. Please make sure that you read them carefully before you start using the automatic functions.

Do

- Familiarise yourself with the use of the programmer.
- Select foods which are as fresh as possible, and as cold as possible - ie; preferably straight from the refrigerator.
- Choose foods which are suitable for cooking from a cold start, as some dishes will be affected by being left uncooked, at room temperature, perhaps for several hours, especially when the weather is hot.
- Make sure that meat, poultry and uncooked food are thoroughly thawed before placing them in the oven.
- Cover dishes with lids or foil, as they may be left standing in the oven for some time before cooking.

Do not

- Never place warm food in the oven for delayed cooking - eg; stews prepared by frying meat first must be thoroughly cooled before placing in the oven.
- Do not cook dishes containing left over cooked meat or poultry, or pastry dishes with wet fillings, as they are not suitable for automatic cooking.
- Do not put food items intended for delayed cooking into a warm oven - allow the oven to cool before setting for delayed cooking.
- Do not over-fill dishes containing liquids, as they might boil over.
- Never leave food in the oven to cool slowly after cooking, serve immediately or refrigerate.

CLEANING

Caution: Any cleaning agent used incorrectly may damage the appliance.

Always let the oven cool before cleaning.

Some cooking operations generate considerable amount of grease, this combined with spillage can become a hazard if allowed to accumulate on the oven through lack of cleaning. In extreme cases this may amount to misuse of the appliance and could invalidate your guarantee.

It is recommended that the appliance is cleaned after open roasting.

Do not use caustic, corrosive or abrasive cleaning products, products containing bleach, coarse wire wool or any hard implements, as they will damage the surfaces.

All parts of the appliance can be safely cleaned with a cloth wrung out in hot soapy water.

Vitreous enamel parts

GRILL PAN, OVEN FLOOR

Use a mild cream cleaner - eg; "Cif".

Stubborn marks may be removed with a moistened "Brillo" pad.

The grill pan may be cleaned in a dishwasher, or with a nylon brush in hot soapy water.

Chrome plated parts

OVEN SHELVES & OVEN SHELF RUNNERS,
GRILL PAN TRIVET

Do not use abrasives or polishes, use a moist soap pad - eg; "Brillo". These items may also be cleaned in a dishwasher.

Note: Oven shelf runners can be removed for cleaning. Grasp the runners, and slide out of the hanging holes as shown.

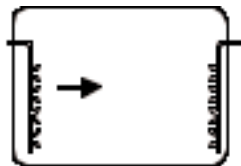

Easy care surfaces

OVEN SIDES AND BACK

We recommend that the appliance is cleaned after open roasting, and also after roasting at temperatures higher than 200°C, to help prevent a build up of fats. Use of a trivet in a roasting tin when roasting will help reduce fat splashing.

Caution: Most types of cleaning agent will damage these surfaces.

Only use a few drops of washing liquid in hot water. Wipe the surfaces with a clean cloth wrung out in hot soapy water - if larger splashes of fat do not readily disappear, scrub the area with a nylon brush or nylon pan scourer and hot soapy water. Rinse well and heat the oven to dry the surfaces.

CLEANING

Glass parts

FACIA PANEL & DOOR PANELS

Use a mild cream cleaner - eg; "Cif". Rinse thoroughly and dry with a soft cloth. Do not use abrasive cleaners or polishes.

To remove the glass panel for cleaning, open the door to the door stop position (about 30° open), hold the top and bottom edges of the panel and slide out. Note that if the door is opened fully when removing the inner door glass panel, the door may spring shut.

Important: if the inner door glass panel is removed for cleaning, it must be replaced the right way up as shown, and pushed fully in to the stop position.

Painted, plastic and metal finish parts

DOOR FRAME & HANDLE, CONTROL KNOB

Only use a clean cloth wrung out in hot soapy water.

Stainless Steel surfaces (stainless steel finish models only)

FACIA PANEL, HANDLES, DOOR PANELS

Only use a clean cloth wrung out in hot soapy water, and dry with a soft cloth.

Stubborn marks can be removed using "Luneta". We recommend that you clean the whole of the stainless steel area to maintain a uniform finish. Supplies can be purchased from the Customer Care Centre.

Do not use undiluted bleach or any products containing chlorides as they can permanently damage the steel.

Extra care should be taken when cooking food in salted water. Some foods are corrosive - eg; vinegar, fruit juices and especially **salt** - they can mark or damage stainless steel if they are left on the surface. Turn off and wipe any spillage immediately, taking care to avoid skin contact with any hot surface or spillage.

Sharp objects can mark the surface of stainless steel, but marks will become less noticeable with time.

To maintain the finish of the stainless steel, or to remove any greasy marks, wipe the stainless steel surface sparingly with a minimum amount of "Johnson's Baby Oil" and kitchen paper.

Do not use cooking oils, as these may contain salt, which can damage the stainless steel surface.

INSTALLATION INSTRUCTIONS

Step 1: Prepare installation

Do not lift the oven by the door handle.

Whilst every care is taken to eliminate burrs and raw edges from this product, please take care when handling - we recommend the use of protective gloves during installation.

Please note that the weight of this appliance is approximately **47kg** (unpacked). Take care when lifting it into the housing unit - always use an appropriate method of lifting.

If this appliance is to be installed near to a corner where the adjacent cabinets run at right angles forward of the appliance, there must be a gap of at least 90mm between the appliance and the cabinets, to prevent overheating of the cabinets.

1. Remove the fixing screws from the polythene bag on the top of the appliance, but leave the appliance in the base tray packaging until you are ready to install it.

Note: When removing the appliance from the base tray packaging care should be taken to ensure the outer frame trim is not damaged.

2. (i) When installed in a typical 600mm deep built in housing unit, the false back should be removed from the housing unit, to provide the necessary depth for installation.

- (ii) When the false back is removed, it is normally the case that the support shelf for the appliance leaves a gap between the back edge and the wall of approximately 80mm.

- (iii) If no gap occurs between the back edge of the shelf and the wall behind the unit, we recommend that a gap of at least 30mm is made by shortening the shelf.

3. The appliance is designed to fit into a standard 600mm wide housing unit, with minimum internal dimensions as shown on page 22.

Please note that all sizes are nominal, some variation is to be expected.

INSTALLATION INSTRUCTIONS

Installation diagram

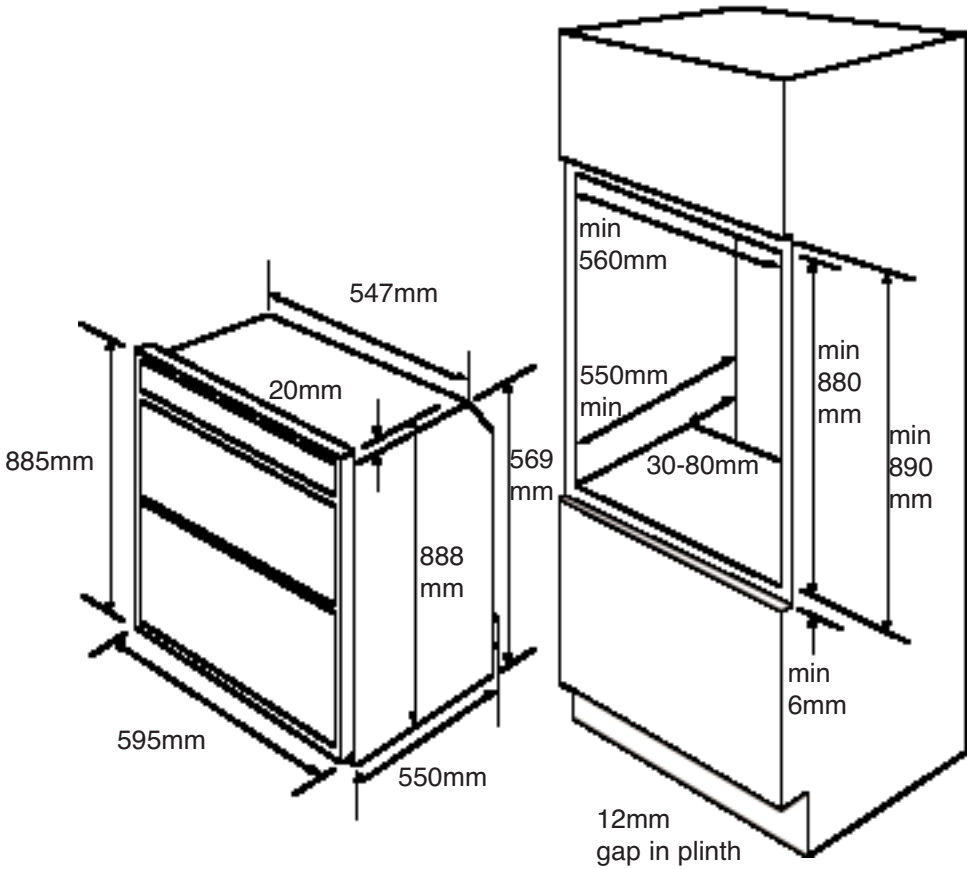

Installation Instructions

Step 2: Connect to the electricity supply

Warning: This appliance must be earthed.

The appliance must be installed by a competent electrician using a double pole control unit of 30 ampere minimum capacity with 3mm minimum contact separation at all poles.

We recommend that the appliance is connected by a qualified electrician who is a member of the N.I.C.E.I.C. and who will comply with the I.E.E. and local regulation.

1. Access to the mains terminal is gained by opening the terminal block cover at the rear of the appliance (use a small flat-bladed screwdriver).
2. Connection should be made with suitable twin and earth heat resistant flexible cable, minimum 4mm², which is suitable for use up to 25 amps.
3. First strip the wires, then push the cable through the cable clamp in the terminal block cover.
4. Connect the cable to the terminal block and tighten the cable clamp cover.
5. Close the terminal box, ensuring that the cover is engaged on the locking tabs.

Step 3: Secure appliance into housing unit

Insert appliance into cabinet.

Note: The unit housing the appliance must be appropriately fixed.

To secure appliance to housing unit

Note: Ensure that the appliance is centrally located.

Take care not to damage the appliance or cabinet.

There are 6 securing screws.

- Open the grill / top oven door, and screw 2 screws through the top corner holes in the front frame.
- With the grill / top oven door still open, screw 2 screws through the holes in the front frame, located under the grill compartment.
Close the grill / top oven door.
- Open the main oven door, and screw the remaining 2 screws through the bottom corner holes in the front frame.
Close the main oven door.

TECHNICAL DATA

Electrical supply

220 - 240V ~ 50Hz

Load / Wattage

4280 W - 5095 W

Belling Customer Care

Please keep this handbook in a safe place as the information inside may be of use should you sell, or pass on the appliance. Please fill in the model number and serial number in the spaces provided below as they will assist us should you need to call.

0844 815 3746

When you dial this number you will hear a recorded message and be given a number of options. This indicates that your call has been accepted and is being held in a queue. Calls are answered in strict rotation as our Customer Care Representatives become available.

Enter appliance numbers here for future reference:

Model No									
4	4	4							
Serial No									

These numbers can be found on your appliances data badge.
Outside the UK and Northern Ireland, refer to your local supplier.